



EurotestPV Lite
MI 3109
Instruction manual
Version 1.8.9, Code no. 20 752 022

Distributor:

Manufacturer:

Metrel d.o.o.
Ljubljanska cesta 77
SI-1354 Horjul
Slovenia
<https://www.metrel.si>
info@metrel.si

DATA BACKUP AND LOSS:

It is the user's responsibility to ensure the integrity and security of the data carrier and to regularly backup and validate the integrity of backups of the data. METREL HAS NO OBLIGATION OR LIABILITY FOR ANY LOSS, ALTERATION, DESTRUCTION, DAMAGE, CORRUPTION OR RECOVERY OF USER DATA, REGARDLESS OF WHERE THE DATA IS STORED.



Mark on your equipment certifies that it meets requirements of all subjected EU regulations.



Hereby, Metrel d.o.o. declares that the MI 3109 is in compliance with subjected EU directive. The full text of the EU declaration of conformity is available at the following internet address <https://www.metrel.si/DoC>.

© 2023 METREL

The trade names Metrel®, Smartec®, Eurotest®, Auto Sequence® are trademarks registered in Europe and other countries.

No part of this publication may be reproduced or utilized in any form or by any means without permission in writing from METREL.

Table of contents

1	Preface	5
2	Safety and operational considerations.....	6
2.1	Warnings and notes	6
2.2	Battery and charging	9
2.3	Standards applied	11
3	Instrument description.....	12
3.1	Front panel	12
3.2	Connector panel	13
3.3	Back side.....	14
3.4	Instrument set and accessories.....	15
3.4.1	Standard set MI 3109.....	15
3.4.2	Optional accessories	16
4	Instrument operation.....	17
4.1	Display and sound.....	17
4.1.1	Warnings.....	17
4.1.2	Battery indication.....	17
4.1.3	Messages.....	17
4.1.4	Results	18
4.1.5	Help screens	18
4.1.6	Backlight and contrast adjustments	19
4.2	Function selection	19
4.3	Instruments main menu	20
4.4	Settings	20
4.4.1	Memory	21
4.4.2	Language	21
4.4.3	Date and time.....	21
4.4.4	Initial settings	22
4.4.5	Clamp Settings.....	23
4.4.6	Synchronization (A 1378 - PV Remote unit)	23
4.4.7	Solar settings	25
4.4.8	Accessories.....	28
4.4.9	Communication	28
5	Measurements	32
5.1	Insulation resistance.....	32
5.2	Resistance of earth connection and equipotential bonding	34
5.2.1	<i>R LOWΩ, 200 mA resistance measurement.....</i>	<i>34</i>
5.2.2	<i>Continuous resistance measurement with low current.....</i>	<i>35</i>
5.2.3	<i>Compensation of test leads resistance</i>	<i>36</i>
5.3	PV inverter test.....	37
5.4	PV panel test	42
5.5	Measuring of environmental parameters	44
5.5.1	<i>Operation with A 1378 PV Remote Unit.....</i>	<i>46</i>
5.6	Uoc / Isc measurement.....	46
5.7	I / V curve measurement	48
5.8	Automatic measurement procedure according to IEC/ EN 62446 (Auto)	50
5.9	Measurement of cell temperature before test.....	52

6	Data handling	53
6.1	Memory organization	53
6.2	Data structure	53
6.3	Storing test results	55
6.4	Recalling test results	56
6.5	Clearing stored data	57
6.5.1	Clearing complete memory content	57
6.5.2	Clearing measurement(s) in selected location	57
6.5.3	Clearing individual measurements	58
6.5.4	Renaming installation structure elements (upload from PC)	59
6.5.5	Renaming installation structure elements with serial barcode reader or RFID reader	59
6.6	Communication	60
6.6.1	USB and RS232 communication	60
6.6.2	Bluetooth communication	61
7	Upgrading the instrument	63
8	Maintenance	64
8.1	Fuse replacement	64
8.2	Cleaning	64
8.3	Periodic calibration	64
8.4	Service	64
9	Technical specifications	65
9.1	Insulation resistance (of PV systems) R_{oc+} , R_{oc-} and R_{oc}	65
9.2	Continuity	66
9.2.1	Resistance $R_{LOW\Omega}$	66
9.2.2	Resistance <i>CONTINUITY</i>	66
9.3	PV tests	67
9.3.1	Accuracy of STC data	67
9.3.2	Panel, Inverter	67
9.3.3	I-V curve	68
9.3.4	U_{oc} - I_{sc}	68
9.3.5	Environmental parameters	69
9.4	Autotest	69
9.5	General data	70
Appendix B - Accessories for specific measurements		71
Appendix E – PV measurements - calculated values		72

1 Preface

Congratulations on your purchase of the EurotestPV Lite instrument and its accessories from METREL. The instrument was designed on a basis of rich experience, acquired through many years of dealing with electric installation test equipment.

The EurotestPV Lite instrument is a professional, multifunctional, hand-held test instrument intended to perform all measurements on photovoltaic systems.

Measurements and tests on PV systems (on a.c. and d.c. part):

- ❑ Continuity tests,
- ❑ Insulation resistance on PV systems,
- ❑ Voltages, currents and power in PV systems (Inverter and PV panels),
- ❑ Calculation of efficiencies and STC values in PV systems,
- ❑ Uoc / Isc measurements,
- ❑ Environmental parameters (Temperature and Irradiance),
- ❑ I-V curve test,
- ❑ Automatic test procedure acc. to IEC/ EN 62446.

The graphic display with backlight offers easy reading of results, indications, measurement parameters and messages. Two LED Pass/Fail indicators are placed at the sides of the LCD.

The operation of the instrument is designed to be as simple and clear as possible and no special training (except for the reading this instruction manual) is required in order to begin using the instrument.

The instrument is equipped with the entire necessary accessory for comfortable testing.

2 Safety and operational considerations

2.1 Warnings and notes

In order to maintain the highest level of operator safety while carrying out various tests and measurements, Metrel recommends keeping your EurotestPV Lite instrument in good condition and undamaged. When using the instrument, consider the following general warnings:



General warnings related to safety:

- ❑ The  symbol on the instrument means »Read the Instruction manual with special care for safe operation«. The symbol requires an action!
- ❑ If the test equipment is used in a manner not specified in this user manual, the protection provided by the equipment could be impaired!
- ❑ Read this user manual carefully, otherwise the use of the instrument may be dangerous for the operator, the instrument or for the equipment under test!
- ❑ Do not use the instrument or any of the accessories if any damage is noticed!
- ❑ Consider all generally known precautions in order to avoid risk of electric shock while dealing with hazardous voltages!
- ❑ If a fuse blows, follow the instructions in this manual in order to replace it! Use only fuses that are specified!
- ❑ Do not use the instrument in AC supply systems with voltages higher than 550 V a.c.
- ❑ Do not use the instrument in PV systems with voltages higher than 1000 V d.c. and/ or currents higher than 15 A d.c.! Otherwise, the instrument can be damaged.
- ❑ Service, repairs or adjustment of instruments and accessories is only allowed to be carried out by competent authorized personnel!
- ❑ The instrument comes supplied with rechargeable Ni-MH battery cells. The cells should only be replaced with the same type as defined on the battery compartment label or as described in this manual. Do not use standard alkaline battery cells while the power supply adapter is connected, otherwise they may explode!
- ❑ Hazardous voltages exist inside the instrument. Disconnect all test leads, remove the power supply cable and switch off the instrument before removing battery compartment cover.
- ❑ Do not connect any voltage source on C1 and P/C2 inputs. They are intended only for connection of current clamps and sensors. Maximal input voltage is 3 V!

- ❑ All normal safety precautions must be taken in order to avoid risk of electric shock while working on electrical installations!
- ❑ PV sources can produce very high voltages and currents. Only skilled and trained personnel should perform measurements on photovoltaic systems.
- ❑ Local regulations should be considered.
- ❑ Safety precautions for working on the roof should be considered.
- ❑ In case of a fault in the measuring system (wires, devices, connections, measuring instrument, accessories...), presence of flammable gases, very high moisture or heavy dust an electrical arc can occur that will not extinguish by itself. Arcs can lead to fire and can cause heavy damage. Users must be skilled to disconnect the PV system safely in this case.
- ❑ Use only dedicated measuring accessories for testing on PV electrical installations. Metrel accessories for PV installations have yellow marked connectors.
- ❑ Consider that protection category of some accessories is lower than of the instrument. Test tips have removable caps. If they are removed the protection falls to CAT II. Check markings on accessories!
(cap off, 18 mm tip)...CAT II up to 1000 V
(cap on, 4 mm tip)... CAT II 1000 V / CAT III 600 V / CAT IV 300 V
- ❑ PV Safety probe A 1384 provides additional safety when working on PV installations. It has an inbuilt protective circuit that safely disconnects the instrument from the PV installation in case of a failure in the instrument (see chapter 4.4.8 Accessories for more information).
- ❑ PV test lead A1385 has integrated fuses that safely disconnects instrument from the PV installation in case of a failure in the instrument.
- ❑ If a voltage higher than 1000 V d.c. is detected on any of the measuring inputs further measurements will be blocked and the  warning is displayed.



Warnings related to safety of measurement functions:

Insulation resistance of PV systems

- ❑ Do not touch the test object during the measurement or before it is fully discharged! Risk of electric shock!
- ❑ When an insulation resistance measurement has been performed on a capacitive object, automatic discharge may not be done immediately! The warning message  and the actual voltage are displayed during discharge until voltage drops below 10 V.

Continuity functions

- ❑ **Continuity measurements should only be performed on de-energized objects!**

Notes related to measurement functions:

General

- ❑ PASS / FAIL indication is enabled when limit is set. Apply appropriate limit value for evaluation of measurement results.
- ❑ The A 1384 PV Safety Probe provides additional safety and can be optionally used for PANEL, UOC/ISC, I/V, INVERTER (AC, DC) and RISO measurements.
- ❑ Fused A 1385 PV test lead must be used for INVERTER AC/DC measurements.
- ❑ PV continuity test lead should be used for the Continuity tests.

Insulation resistance of PV systems

- ❑ The instrument automatically discharge tested object after finished measurement.
- ❑ A double click of TEST key starts a continuous measurement.
- ❑ The insulation measurement is carried out according to test method 1 in IEC / EN 62446 (Test between panel / string / array negative and earth followed by a test between panel / string / array Positive and earth).

Continuity functions

- ❑ If a voltage of higher than 10 V (AC or DC) is detected between test terminals, the continuity resistance test will not be performed.
- ❑ Before performing a continuity measurement, where necessary, compensate test lead resistance.
- ❑ Parallel loops may influence test results.

Panel, Inverter, Uoc/Isc, I-V

- ❑ Before starting a PV measurement, the settings of PV module type and PV test parameters should be checked.
- ❑ Environmental parameters (Irr, T) can be measured or entered manually.
- ❑ Environmental conditions (irradiance, temperature) must be stable during the measurements.
- ❑ For calculation of STC results measured Uoc / Isc values, irradiance, cell temperature, and PV module parameters must be known. Refer to Appendix E for more information.
- ❑ Always perform zeroing of DC current clamps before test.

Auto

- ❑ Consider all notes for individual tests.
- ❑ The Automatic test cannot be carried out with the A 1384 PV Safety Probe.
- ❑ The insulation resistance results may slightly differ in comparison to results in Single test mode because of the three-wire connection and the internal resistance of the measuring instrument.

2.2 Battery and charging

The instrument uses six AA size alkaline or rechargeable Ni-MH battery cells. Nominal operating time is declared for cells with nominal capacity of 2100 mAh. Battery condition is always displayed in the lower right display part. In case the battery is too weak the instrument indicates this as shown in figure 2.1. This indication appears for a few seconds and then the instrument turns itself off.

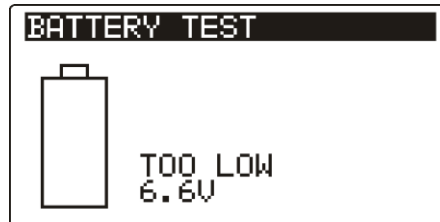

Figure 2.1: Discharged battery indication

The battery is charged whenever the power supply adapter is connected to the instrument. The power supply socket polarity is shown in figure 2.2. Internal circuit controls charging and assures maximum battery lifetime.



Figure 2.2: Power supply socket polarity

Symbols:

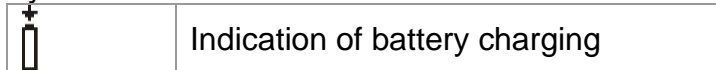

Figure 2.3: Charging indication



Warnings related to safety:

- ❑ When connected to an installation, the instruments battery compartment can contain hazardous voltage inside! When replacing battery cells or before opening the battery/fuse compartment cover, disconnect any measuring accessory connected to the instrument and turn off the instrument,
- ❑ Ensure that the battery cells are inserted correctly otherwise the instrument will not operate and the batteries could be discharged.
- ❑ Do not recharge alkaline battery cells!
- ❑ Use only power supply adapter delivered from the manufacturer or distributor of the test equipment!

Notes:

- ❑ The charger in the instrument is a pack cell charger. This means that the battery cells are connected in series during the charging. The battery cells have to be equivalent (same charge condition, same type and age).

- If the instrument is not to be used for a long period of time, remove all batteries from the battery compartment.
- Alkaline or rechargeable Ni-MH batteries (size AA) can be used. Metrel recommends only using rechargeable batteries with a capacity of 2100mAh or above.
- Unpredictable chemical processes can occur during the charging of battery cells that have been left unused for a longer period (more than 6 months). In this case Metrel recommends repeating the charge / discharge cycle at least 2-4 times.
- If no improvement is achieved after several charge / discharge cycles, then each battery cell should be checked (by comparing battery voltages, testing them in a cell charger, etc). It is very likely that only some of the battery cells are deteriorated. One different battery cell can cause an improper behavior of the entire battery pack!
- The effects described above should not be confused with the normal decrease of battery capacity over time. Battery also loses some capacity when it is repeatedly charged / discharged. This information is provided in the technical specification from battery manufacturer.

2.3 Standards applied

The EurotestPV Lite instruments are manufactured and tested in accordance with the following regulations:

Electromagnetic compatibility (EMC)

EN 61326-1	Electrical equipment for measurement, control and laboratory use – EMC requirements – Part 1: General requirements
EN 61326-2-2	Electrical equipment for measurement, control and laboratory use – EMC requirements – Part 2-2: Particular requirements - Test configurations, operational conditions and performance criteria for portable test, measuring and monitoring equipment used in low-voltage distribution systems

Safety (LVD)

EN 61010-1	Safety requirements for electrical equipment for measurement, control and laboratory use – Part 1: General requirements
EN 61010-2-030	Safety requirements for electrical equipment for measurement, control and laboratory use – Part 2-030: Particular requirements for testing and measuring circuits
EN 61010-031	Safety requirements for electrical equipment for measurement, control and laboratory use – Part 031: Safety requirements for hand-held probe assemblies for electrical measurement and test
EN 61010-2-032	Safety requirements for electrical equipment for measurement, control, and laboratory use - Part 2-032: Particular requirements for hand-held and hand-manipulated current sensors for electrical test and measurement

Functionality

EN 61557	Electrical safety in low voltage distribution systems up to 1000 V _{AC} and 1500 V _{AC} – Equipment for testing, measuring or monitoring of protective measures Part 1 General requirements Part 2 Insulation resistance Part 4 Resistance of earth connection and equipotential bonding Part 10 Combined measuring equipment
----------	---

Reference standard for photovoltaic systems

EN 62446	Grid connected photovoltaic systems – Minimum requirements for system documentation, commissioning tests and inspection
EN 61829	Crystalline silicon photovoltaic (PV) array – On-site measurement of I / V characteristics

Note about EN and IEC standards:

- Text of this manual contains references to European standards. All standards of EN 6XXXX (e.g. EN 61010) series are equivalent to IEC standards with the same number (e.g. IEC 61010) and differ only in amended parts required by European harmonization procedure.

3 Instrument description

3.1 Front panel

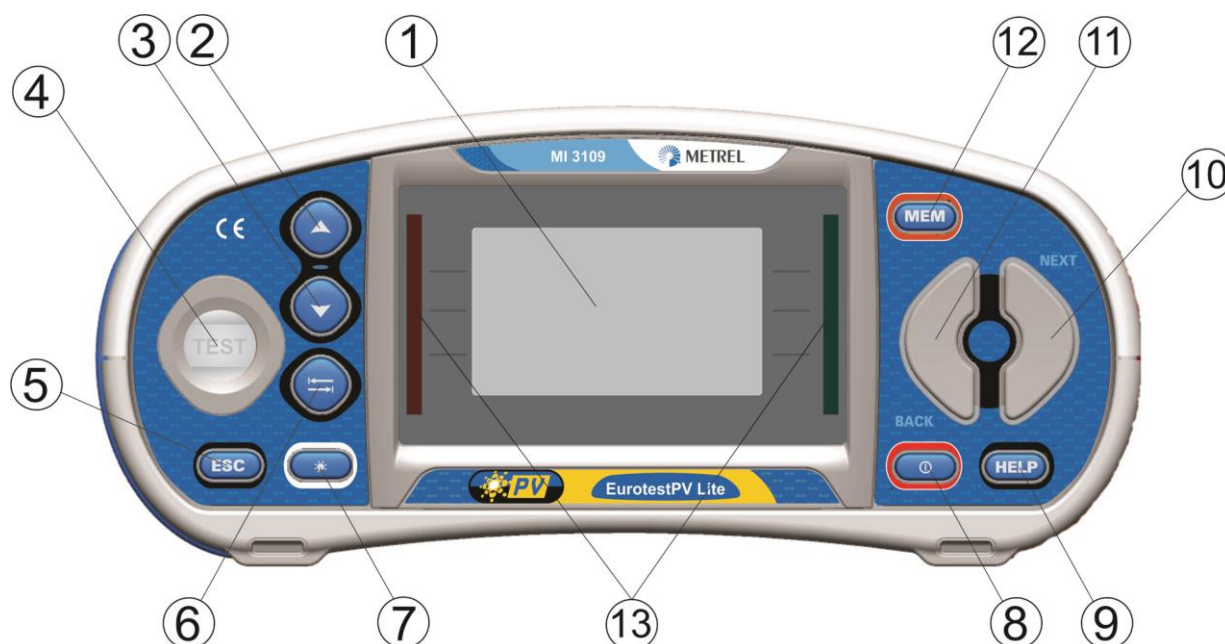

Figure 3.1: Front panel

Legend:

1	LCD	128 x 64 dots matrix display with backlight.
2	▲	Modifies selected parameter.
3	▼	
4	TEST	Starts measurements.
5	ESC	Goes one level back.
6	TAB	Selects the parameters in selected function.
7	Backlight, Contrast	Changes backlight level and contrast.
8	ON / OFF	Switches the instrument power on or off. <i>The instrument automatically turns off 15 minutes after the last key was pressed</i>
9	HELP / CAL	Accesses help menus. Calibrates test leads in Continuity functions.
10	Function selector - NEXT	Selects test function.
11	Function selector - BACK	
12	MEM	Stores / recalls memory of instrument. Stores clamp and solar settings.
13	Green LED Red LED	Indicates PASS / FAIL of result.

3.2 Connector panel

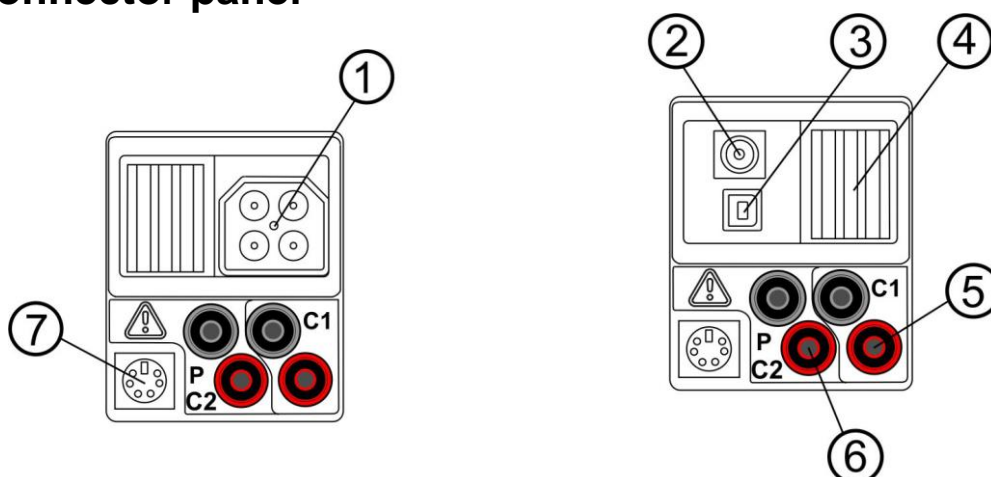

Figure 3.2: Connector panel

Legend:

1	Test connector	Measuring inputs / outputs
2	Charger socket	
3	USB connector	Communication with PC USB (1.1) port.
4	Protection cover	
5	C1	Current clamp measuring input #1
6	P/C2	Current clamp measuring input #2 Measuring input for external probes
7	PS/2 connector	Communication with PC serial port Connection to optional measuring adapters Connection to barcode / RFID reader Connection to Bluetooth dongle

Warnings!

- ❑ **Maximum allowed voltage between any test terminal and ground is 550 V a.c. or 1000 V d.c.!**
- ❑ **Maximum allowed voltage between test terminals on test connector is 600 V a.c. or 1000 V d.c.!**
- ❑ **Maximum allowed voltage between test terminals P/C2, C1 is 3 V!**
- ❑ **Maximum short-term voltage of external power supply adapter is 14 V!**

3.3 Back side

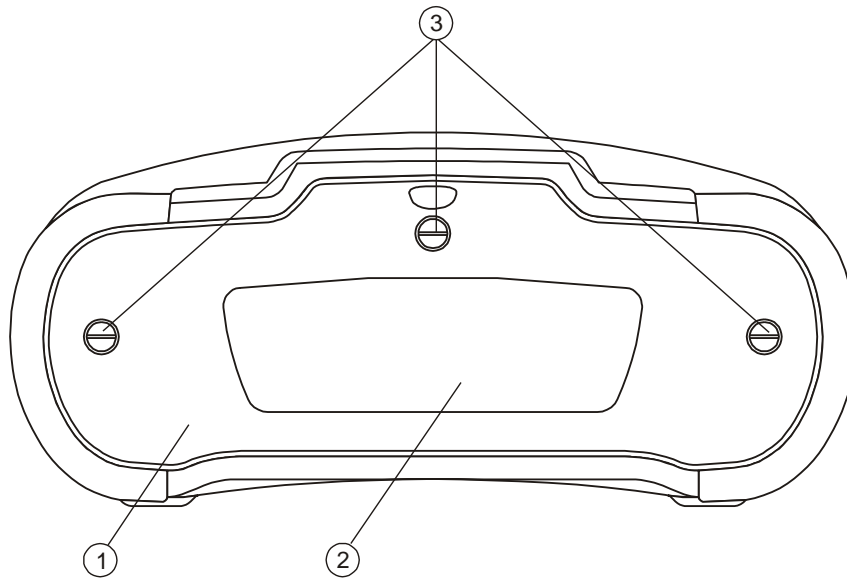

Figure 3.3: Back panel

Legend:

- | | |
|---|--|
| 1 | Battery / fuse compartment cover |
| 2 | Back panel information label |
| 3 | Fixing screws for battery / fuse compartment cover |

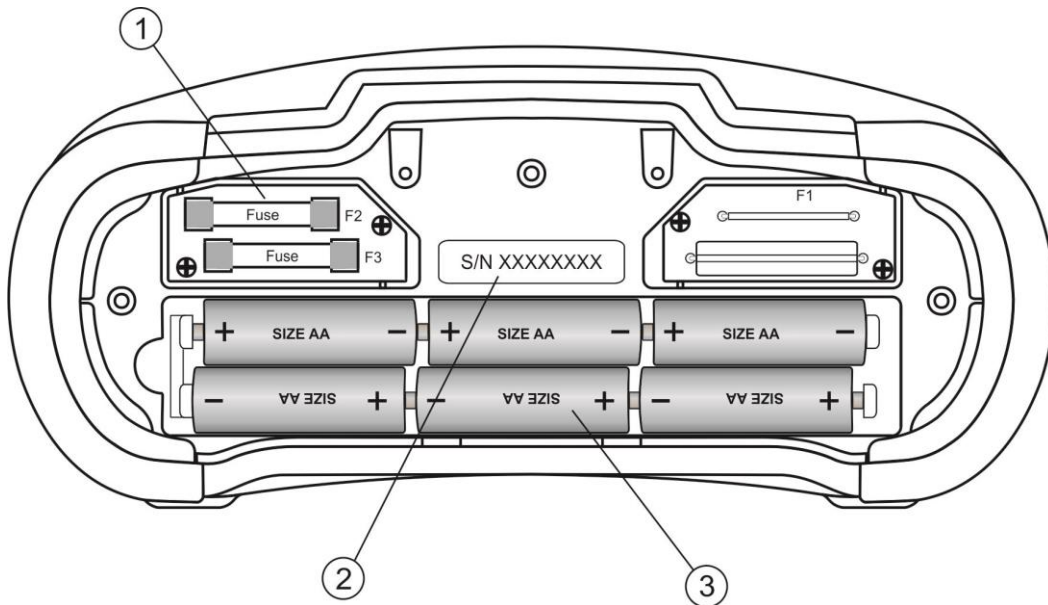

Figure 3.4: Battery and fuse compartment

Legend:

- | | | |
|---|---------------------|---|
| 1 | Fuse F2, F3 | FF 315 mA / 1000 V d.c.
(Breaking capacity: 50 kA) |
| 2 | Serial number label | |
| 3 | Battery cells | Size AA, alkaline / rechargeable NiMH |

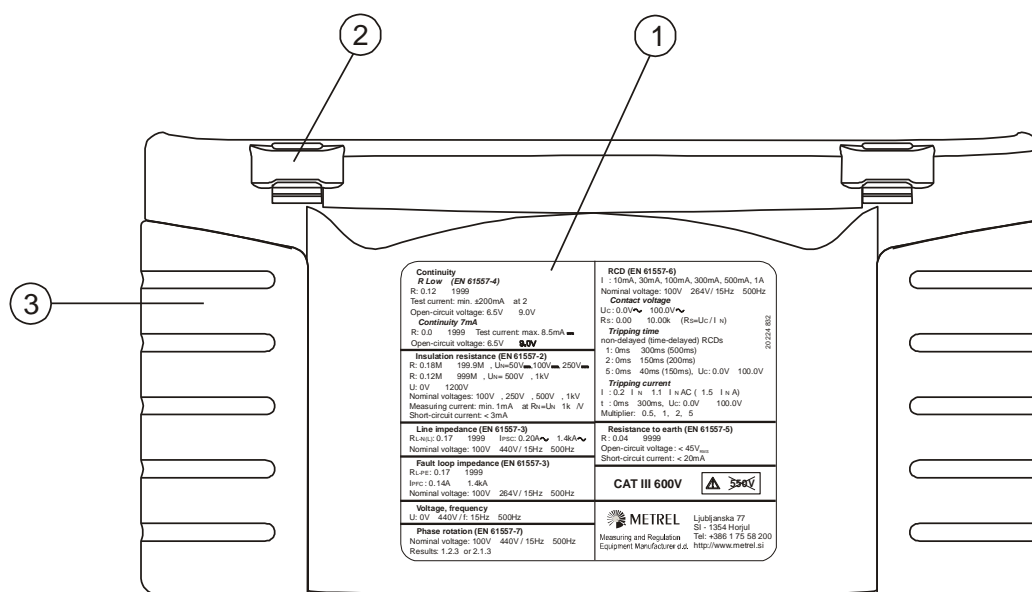

Figure 3.5: Bottom

Legend:

- | | |
|---|--------------------------|
| 1 | Bottom information label |
| 2 | Neck belt openings |
| 3 | Handling side covers |

3.4 Instrument set and accessories

3.4.1 Standard set MI 3109

- Instrument
- Soft carrying bag
- AC / DC current clamp
- Universal PV test lead, 3 x 1.5 m
- PV continuity test lead, 2 x 1.5 m
- Test probe, 3 pcs
- Crocodile clip, 3 pcs
- PV MC 4 adapter male
- PV MC 4 adapter female
- PV MC 3 adapter male
- PV MC 3 adapter female
- Set of NiMH battery cells
- Power supply adapter
- Set of carrying straps
- RS232-PS/2 cable
- USB cable
- CD with instruction manual
- Short instruction manual
- Calibration Certificate







3.4.2 Optional accessories

See the attached sheet for a list of optional accessories that are available on request from your distributor.

4 Instrument operation

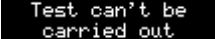

4.1 Display and sound

4.1.1 Warnings

	The A 1384 PV Safety Probe should be used for the selected test. Refer to chapter 4.4.8 Accessories for more information about use of A 1384.
	The conditions on measuring inputs do not allow continuing the test. Check measuring connections.
	The voltage conditions on measuring inputs do not allow continuing the test. Check measuring connections.
	External DC voltage of higher than 50 V is applied to the instrument. Measurements are blocked.
	The selected test cannot be carried out with the A 1384 PV Safety Probe.
	Fused A 1385 test lead should be used for the test.





4.1.2 Battery indication







The battery indication indicates the charge condition of battery and connection of external charger.

	Battery capacity indication.
	Low battery. Battery is too weak to guarantee correct result. Replace or recharge the battery cells.
	Charging in progress (if power supply adapter is connected).



4.1.3 Messages

Following warnings and messages are displayed.

	The change in irradiance during the measurement was above the set limit (Warn. Irr).
	The difference between the Uoc STC based on measurement and Uoc STC value based on set PV module and number of modules in the string is above the set limit (Warn. Uoc).
	Measurement is running, consider displayed warnings.
	Instrument is overheated. The measurement is prohibited until the temperature decreases under the allowed limit.
	Result(s) can be stored.

	Warning! High voltage is applied to the test terminals.
	Test leads resistance in Continuity measurement is not compensated.
	Test leads resistance in Continuity measurement is compensated.
	Too small current for declared accuracy. Results may be impaired. Check in Current Clamp Settings if sensitivity of current clamp can be increased.
	Measured signal is out of range (clipped). Results are impaired.
	External DC voltage is detected. Measurements are blocked.
	Fuse is broken.

4.1.4 Results

	Measurement result is inside pre-set limits (PASS).
	Measurement result is out of pre-set limits (FAIL).

4.1.5 Help screens

HELP	Opens help screen.
-------------	--------------------

Help menus are available in all functions. The Help menu contains schematic diagrams for illustrating how to properly connect the instrument to electric installation or PV system. After selecting the measurement, you want to perform, press the HELP key in order to view the associated Help menu.

Keys in help menu:

▲ / ▼	Selects next / previous help screen.
ESC/ HELP / Function selector	Exits help menu.

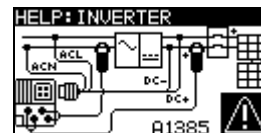
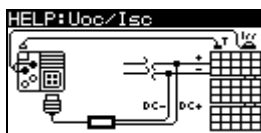

Figure 4.1: Examples of help screens

4.1.6 Backlight and contrast adjustments

With the **BACKLIGHT** key backlight and contrast can be adjusted.

Click	Toggles backlight intensity level.
Keep pressed for 1 s	Locks high intensity backlight level until power is turned off or the key is pressed again.
Keep pressed for 2 s	Bargraph for LCD contrast adjustment is displayed.



Figure 4.2: Contrast adjustment menu

Keys for contrast adjustment:

▲	Increases contrast.
▼	Reduces contrast.
TEST	Accepts new contrast.
ESC	Exits without changes.

4.2 Function selection

For selecting test / measurement function within each test mode the **FUNCTION SELECTOR** keys shall be used.

Keys:

Function selector	Selects test / measurement function.
▲ / ▼	Selects sub-function in selected measurement function. Selects screen to be viewed (if results are split into more screens).
TAB	Selects the test parameter to be set or modified.
TEST	Runs selected test / measurement function.
MEM	Stores measured results / recalls stored results.
ESC	Exits back to main menu.

Keys in **test parameter** field:

▲ / ▼	Changes the selected parameter.
TAB	Selects the next measuring parameter.
Function selector	Toggles between the main functions.
MEM	Stores measured results / recalls stored results

General rule regarding enabling **parameters** for evaluation of measurement / test result:

Parameter	OFF	No limit values, indication: _ _ _.
	ON	Value(s) – results will be marked as PASS or FAIL in accordance with selected limit.

See *Chapter 5* for more information about the operation of the instrument test functions.

4.3 Instruments main menu

In instrument’s main menu the test mode can be selected. Different instrument options can be set in the **SETTINGS** menu.

- ❑ <**SINGLE TEST**> individual tests
- ❑ <**AUTOTEST**> test sequence acc. to IEC/ EN 62446
- ❑ <**SETTINGS**> Instrument settings

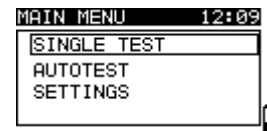

Figure 4.3: Main menu

Keys:

▲ / ▼	Selects appropriate option.
TEST	Enters selected option.

4.4 Settings

Different instrument options can be set in the **SETTINGS** menu.

Options are:

- ❑ Recalling and clearing stored results
- ❑ Selection of language
- ❑ Setting the date and time
- ❑ Setting the instrument to initial values
- ❑ Settings for current clamps
- ❑ Menu for synchronization with PV Remote unit
- ❑ Settings for PV measurements
- ❑ Settings of accessories
- ❑ Settings for Bluetooth communication

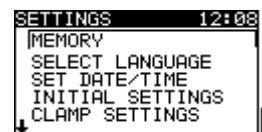

Figure 4.4: Settings menu

Keys:

▲ / ▼	Selects appropriate option.
TEST	Enters selected option.
ESC / Function selector	Exits back to main menu.

4.4.1 Memory

In this menu the stored data can be recalled or deleted. See chapter 8 *Data handling* for more information.

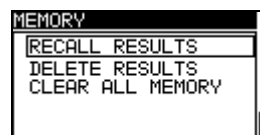

Figure 4.5: Memory options

Keys:

▲ / ▼	Selects option.
TEST	Enters selected option.
ESC	Exits back to settings menu.
Function selector	Exits back to main menu without changes.

4.4.2 Language

In this menu the language can be set.



Figure 4.6: Language selection

Keys:

▲ / ▼	Selects language.
TEST	Confirms selected language and exits to settings menu.
ESC	Exits back to settings menu.
Function selector	Exits back to main menu without changes.

4.4.3 Date and time

In this menu date and time can be set.

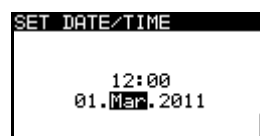

Figure 4.7: Setting date and time

Keys:

TAB	Selects the field to be changed.
▲ / ▼	Modifies selected field.
TEST	Confirms new date / time and exits.
ESC	Exits back to settings menu.
Function selector	Exits back to main menu without changes.

Warning:

- If the batteries are removed for more than 1 minute the set date and time will be lost.

4.4.4 Initial settings

In this menu the instrument settings, measurement parameters and limits can be set to initial (factory) values.

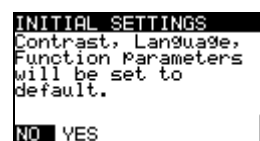

Figure 4.8: Initial settings dialogue

Keys:

▲ / ▼	Selects option [YES, NO].
TEST	Restores default settings (if YES is selected).
ESC	Exits back to settings menu.
Function selector	Exits back to main menu without changes.

Warning:

- ❑ Customized settings will be lost when this option is used!
- ❑ If the batteries are removed for more than 1 minute the custom made settings will be lost.

The default setup is listed below:

Instrument setting	Default value
Language	English
Contrast	As defined and stored by adjustment procedure
Communication	RS232
Clamp settings	
CLAMP 1	A 1391, 40A
CLAMP 2	A 1391, 40A
Accessories	Test cable
Solar settings	See chapter 4.4.10 Solar Settings

Function Sub-function	Parameters / limit value
ISO	No limit
RISO+, RISO-	Utest = 500 V
ENV.	Measured
I/V	Measured
INVERTER	AC/ DC
AUTO	No limit
	Utest = 500 V

Note:

- ❑ Initial settings (reset of the instrument) can be recalled also if the TAB key is pressed while the instrument is switched on.

4.4.5 Clamp Settings

In Clamp settings menu the C1 and C2/P measuring inputs can be configured.

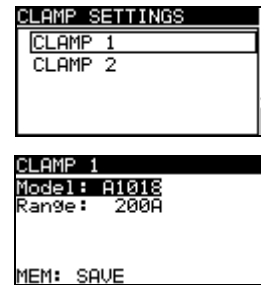

Figure 4.9: Configuration of current clamp measuring inputs

Parameters to be set:

Model	Model of current clamp [A 1018, A 1019, A 1391].
Range	Measuring range of current clamp [20 A, 200 A], [40 A, 300 A].

Selection of measuring parameters

Keys

▲ / ▼	Selects appropriate option.
TEST	Enables changing data of selected parameter.
MEM	Saves settings.
ESC	Exits back to clamp settings menu.
Function selector	Exits back to main menu without changes.

Changing data of selected parameter

Keys

▲ / ▼	Sets parameter.
TEST	Confirms set data.
ESC	Disable changing data of selected parameter.
Function selector	Exits back to main menu without changes.

Note:

- Measuring range of the instrument must be considered. Measurement range of current clamp can be higher than of the instrument.

4.4.6 Synchronization (A 1378 - PV Remote unit)

The main purpose of the synchronization is:

- to get correct values of temperature and irradiance for calculation of STC measurement results.
- to get values of cell temperature up to 15 minutes before the PV tests in order to have an evidence that the measurement conditions were equilibrated during the PV tests.

During the PV tests the displayed STC results are calculated on base of set or measured environmental data in the instrument's **Environmental menu**. These values are not necessarily measured at the same time as other measurements.

Synchronization (of time stamps) enables to later update the PV measured results with environmental data that were measured simultaneously with the A 1378 PV Remote unit. Stored STC values are then corrected accordingly.

Selecting this option will allow synchronization of data between the instrument and PV Remote unit.

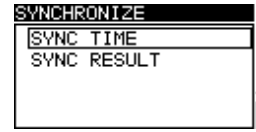

Figure 4.10: Synchronize menu

Data to be synchronized:

TIME	Instrument's time and date will be uploaded to the PV Remote unit.
RESULT	Values of measured environmental parameters will be downloaded to the instrument. Saved STC results will be corrected accordingly.

Keys:

▲ / ▼	Selects data to be synchronized.
TEST	Synchronizes data. Follow the information on the LCD. If the synchronization succeeded a confirmation beep will follow after short connecting... and synchronizing... messages.
ESC	Exits back to settings menu.
Function selector	Exits back to main menu.

Connection for synchronization

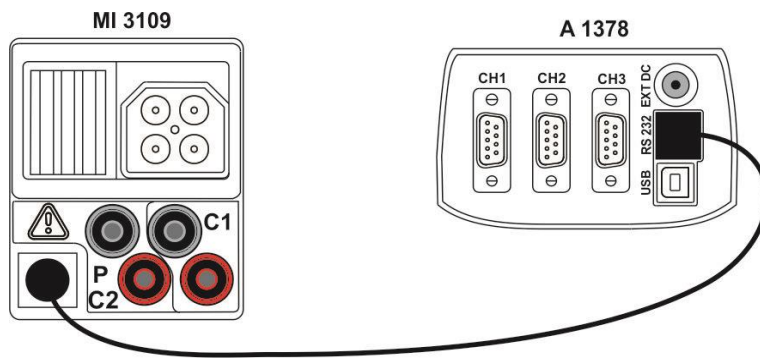

Figure 4.11: Connection of the instruments during synchronization

Note:

- Refer to A 1378 PV Remote unit user manual for more information.

4.4.7 Solar settings

In Solar settings parameters of PV modules and settings for PV measurements can be set.

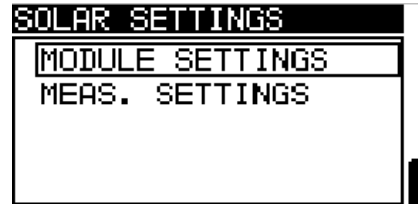

Figure 4.12: Solar settings

Keys:

▲ / ▼	Selects option.
TEST	Enters menu for changing parameters.
ESC	Exits back to settings menu.
Function selector	Exits back to main menu without changes.

PV module settings

Parameters of PV modules can be set in this menu. A database for up to 20 PV modules can be created / edited. Parameters are used for calculation of STC values.

Note:

- The database can be also created on the PC or mobile device and then sent to the instrument. PCSW EurolinkPRO, Metrel ES Manager, and some Android applications support this feature.

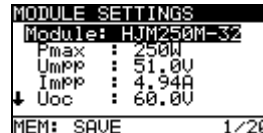

Figure 4.13: PV module settings menu

Parameters of PV module:

Module		PV module name
Pmax	1 W ..2000 W	Nominal power of PV module
Umpp	1.0 V .. 999 V	Voltage on maximum power point
Impp	0.01 A .. 15.0 A	Current on maximum power point
Uoc	1.0 V .. 999 V	Open circuit voltage of module
Isc	0.01 A .. 15.0 A	Short circuit current of module
NOCT	1.0 °C .. 99.0 °C	Nominal working temperature of PV cell
alfa	-5.00 mA/°C .. 300 mA/°C	Temperature coefficient of Isc
beta	-5.00 V/°C .. -0.001 V/°C	Temperature coefficient of Uoc
gamma	-5.00 %/°C .. 0.999 %/°C	Temperature coefficient of Pmax
Rs	0.01 Ω .. 9.99 Ω	Serial resistance of PV module

Selection of PV module type and parameters

Keys:

▲ / ▼	Selects appropriate option.
TEST	Enters menu for changing type or parameters.
ESC, Function selector	Exits back.
MEM	Enters PV module type memory menu.

Changing a PV module type / parameter

Keys:

▲ / ▼	Sets value / data of parameter / PV module type.
TEST	Confirms set value / data.
ESC, Function selector	Exits back.

PV module type memory menu

ADD	Enters menu for adding a new PV module type.
OVERWRITE	Enters menu for storing changed data of selected PV module type.
DELETE	Deletes selected PV module type.
DELETE ALL	Deletes all PV module types.

Keys:

▲ / ▼	Selects option.
TEST	Enters selected menu.
Function selectors	Exits back to main function menu.

If **Add** or **Overwrite** is selected the menu for setting the PV module type name is displayed.



Figure 4.14: Setting name of PV module type

Keys:

▲ / ▼	Selects a character.
TEST	Selects the next character.
MEM	Confirms new name and stores it in the memory. Then returns to Module settings menu .
ESC	Deletes last letter. Returns to previous menu without changes.

If **Delete** or **Delete all** is selected a warning will be displayed.

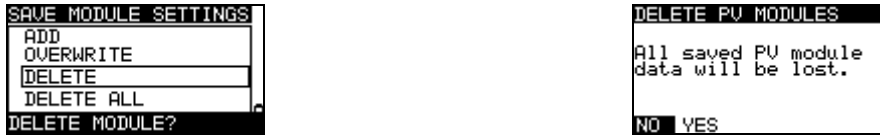

Figure 4.15: Delete options

Keys:

TEST	Confirms clearing. In Delete all option YES must be selected.
ESC	Exits back to PV module type memory menu without changes.
Function selector	Exits back to main function menu without changes.

PV measurements settings

Parameters for PV measurements can be set in this menu.

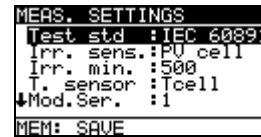

Figure 4.16: Selection of PV measurement settings

Parameters for PV measurements:

Test std	Testing standard [IEC 60891, CEI 82-25]
Irr. Sens.	Type of irradiance measuring sensor [PV cell, Pyran.]
Irr. min.	Minimal valid solar irradiance for calculation [500 – 1000 W/m ²]
T. sensor	Temperature for calculation [Tamb, Tcell]
Mod.Ser.	Number of modules in serial [1 – 30]
Mod.Par.	Number of modules in parallel [1 – 10]
Correct. T	Correction of measured cell temperature to compensate for the difference between the actual cell temperature and the measured temperature. [0 – 5 °C]. According to the EN 61829 standard the difference is typically 2 °C. [Off, 1 °C – 5 °C]
Warn. Irr	Limit for the unstable irradiance warning [Off, 1 % – 20 %]
Warn. Uoc	Limit for the improper Uoc warning [Off, 5 % – 50 %]

Selection of PV test parameters

Keys:

▲ / ▼	Selects appropriate option.
TEST	Enables changing data of selected parameter.
MEM	Saves settings.
ESC / Function selector	Exits back.

Changing data of selected parameter

Keys:

▲ / ▼	Sets parameter.
TEST	Confirms set data.
ESC / Function selector	Exits back.

4.4.8 Accessories

In the Accessories menu options for demanded accessories can be set.

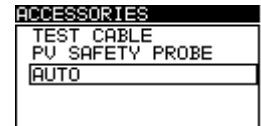

Figure 4.17: Accessories menu

Options are:

TEST CABLE	Measurements are to be carried out with universal PV test lead. If PV Safety Probe is connected to the instrument the measurement results will be wrong.
PV SAFETY PROBE	Measurements can be carried out only with PV Safety Probe.
AUTO	Measurements can be carried out with universal PV test lead or PV Safety Probe. If detected PV Safety Probe has priority.

Keys:

▲ / ▼	Selects option.
TEST	Confirms selected option and exits back to settings menu.
ESC	Exits back to settings menu without changes.
Function selector	Exits back to main menu without changes.

Note

- The A 1384 PV Safety Probe provides additional safety and can be optionally used for PANEL, UOC/ISC, I/V, INVERTER (AC, DC) and RISO measurements. It is not intended for RLOW, CONTINUITY and AUTO tests.

4.4.9 Communication

In this menu the instrument's serial communication port can be configured and Bluetooth dongles A 1436 can be initialized.

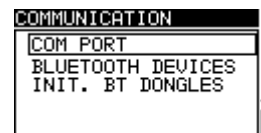

Figure 4.18: Communication menu

Options:

COM PORT	Enters menu for setting serial communication.
BLUETOOTH DEVICES	Enters menu for viewing and selecting Bluetooth devices.
INIT. BT DONGLES	Enters menu for initialization of Bluetooth dongle(s).

Keys:

UP / DOWN	Selects option.
TEST	Confirms selected option.
ESC	Exits back to settings menu.
Function selector	Exits back to main menu without changes.

4.4.9.1 Selecting serial communication

In the COM PORT menu the serial communication can be set (wired, Bluetooth or wireless).

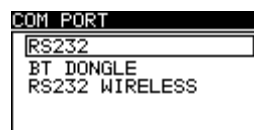

Figure 4.19: Menu for serial communication

Options:

COM PORT	RS232	Communication with external devices via RS232 cable.
	BT DONGLE	Communication with mobile devices, Metrel Powermeters, PCs or other external devices via Bluetooth.
	RS232 WIRELESS	Wireless communication with external devices (A 1378 PV remote unit).

Keys:

UP / DOWN	Selects option.
TEST	Confirms selected option.
ESC	Exits back to Settings menu.
Function selector	Exits back to main menu without changes.

4.4.9.2 Searching for the Metrel Powermeter with Bluetooth connection and pairing with EurotestPV Lite instrument

In the BLUETOOTH DEVICES menu a Metrel Powermeter with Bluetooth connection can be found, selected and paired with the instrument. The Metrel Powermeter must have connected a properly initialized Bluetooth dongle A 1436. See chapter *Initialization of the Bluetooth dongle(s)* for more details.

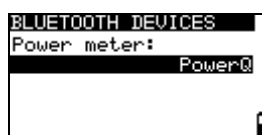

Figure 4.20: Bluetooth devices menu

To select a new Powermeter with Bluetooth connection press TEST in BLUETOOTH DEVICES menu. A list of found Bluetooth devices will be displayed. Select the appropriate device using the arrow keys. Confirmation with TEST key will pair those two instruments.

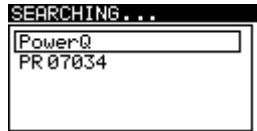

Figure 4.21: Searching and selection of Metrel Powermeter Bluetooth connection

Keys:

UP / DOWN	Selects appropriate Bluetooth device.
TEST	Confirms selected device.
ESC	Exits back to Bluetooth devices menu.
Function selector	Exits back to main menu without changes.

Note:

- This operation must be performed when working with the Powermeter for the first time or if its settings were changed.

4.4.9.3 Initialization of the Bluetooth dongle(s)

The Bluetooth dongle(s) A 1436 should be initialized when they are used for the first time. During initialization the instrument sets the dongle parameters and name in order to communicate properly.



Figure 4.22: Menu for initialization of Bluetooth dongle(s)

INIT. BT DONGLES	EurotestPV Lite	<i>Initializes Bluetooth dongle for EurotestPV Lite instrument.</i>
	PowerQ series	<i>Initializes Bluetooth dongle for Metrel Powermeter.</i>

Keys:

UP / DOWN	Selects option.
TEST	Starts initialization of Bluetooth dongle.
ESC	Exits back to Communication menu.
Function selector	Exits back to main menu without changes.

Initialization procedure (Bluetooth dongle for the EurotestPV Lite instrument):

1. Connect Bluetooth dongle A 1436 to the instrument's PS/2 port.
2. Switch on the instrument.
3. Press a RESET key on the Bluetooth dongle A 1436 for **at least 10 seconds**.
4. **EurotestPV Lite** should be selected in INIT. BT DONGLES menu. Press the TEST key.
5. Wait for confirmation message and beep. Following message is displayed if dongle was initialized properly:

EXTERNAL BT DONGLE SEARCHING OK!

Initialization procedure (Bluetooth dongle for the Metrel Powermeter):

1. Connect Bluetooth dongle A 1436 (intended to be used with the Metrel Powermeter) to the EurotestPV Lite instrument's PS/2 port.
2. Switch on the EurotestPV Lite instrument.
3. Press a RESET key on the Bluetooth dongle A 1436 for **at least 10 seconds**.
4. **PowerQ series** should be selected in INIT. BT DONGLES menu. Press the TEST key.
5. Wait for confirmation message and beep. Following message is displayed if dongle was initialized properly:
EXTERNAL BT DONGLE SEARCHING OK!
6. The successfully initialized Bluetooth dongle A 1436 is now ready to be connected to a Metrel Powermeter.

Notes:

- The Bluetooth dongle A 1436 should always be initialized before first use with the EurotestPV Lite instrument or Metrel Powermeter.
- If the dongle was initialized by another Metrel instrument it will probably not work properly when working with the previous instrument again. Bluetooth dongle initialization should be repeated in that case.
- For more information about communication via Bluetooth refer to chapter 6.6 Communications and A 1436 manual.

5 Measurements

5.1 Insulation resistance

The Insulation resistance measurement is performed in order to ensure safety against electric shock through insulation between live parts on PV installations and earth. The measurement is carried out according to test method 1 in IEC / EN 62446 (test between panel / string / array negative and earth followed by a test between panel / string / array positive and earth).

See chapter 4.2 Function selection for instructions on key functionality. The input voltage is displayed.



Figure 5.1: Insulation resistance

Test parameters for insulation resistance measurement

TEST	Roc-, Roc+
Uiso	Test voltage [50 V, 100 V, 250 V, 500 V, 1000 V]
Limit	Minimum insulation resistance [OFF, 0.01 MΩ ÷ 200 MΩ]

Connection for insulation resistance measurement

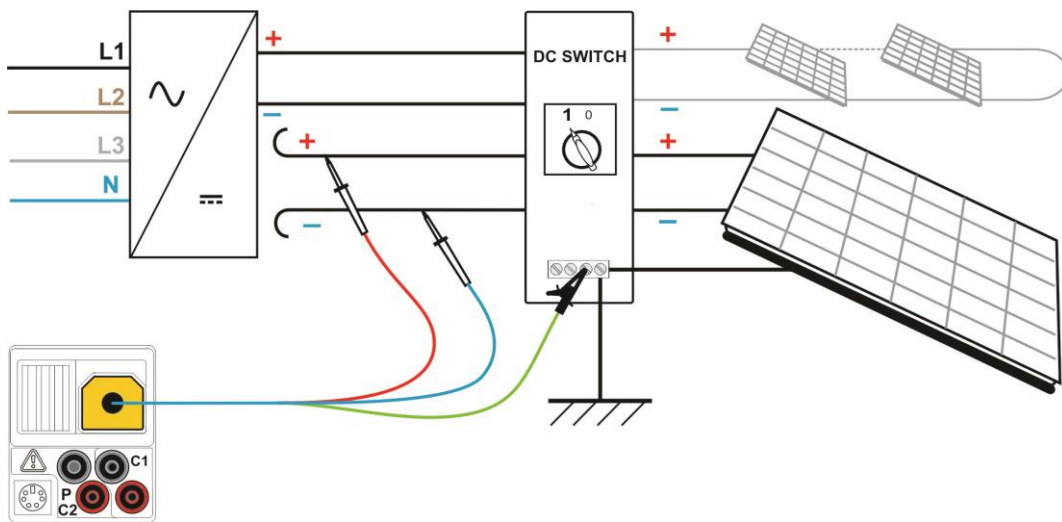

Figure 5.2: Connection for insulation measurement with universal PV test lead

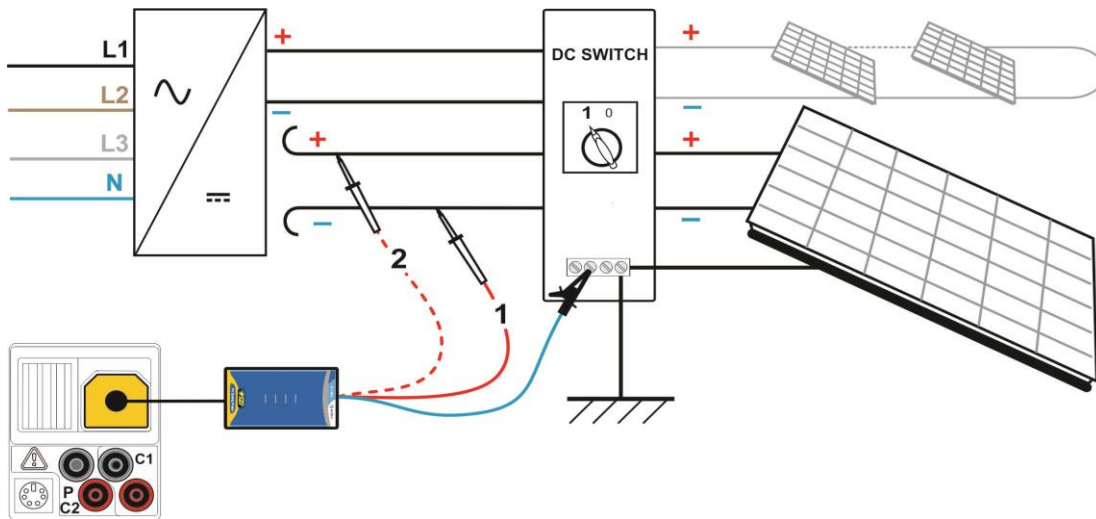

Figure 5.3: Connection for insulation measurement with PV Safety Probe

Insulation resistance measuring procedure

- ❑ Select the **Roc-** sub-function using the function selector keys and $\blacktriangle / \blacktriangledown$ keys.
- ❑ Set the required **test voltage**.
- ❑ Enable and set **limit** value (optional).
- ❑ **Connect** universal PV test lead or PV Safety probe (A 1384) to the instrument (see Figure 5.2 and Figure 5.3)
- ❑ **Connect** universal PV test lead or PV Safety probe (A 1384) to the PV system (see Figure 5.2 and Figure 5.3 - step 1).
- ❑ Press the **TEST** key to perform the measurement (double click for continuous measurement and later press to stop the measurement).
- ❑ After the measurement is finished wait until tested item is fully discharged.
- ❑ **Store** the result by pressing the **MEM** key (optional).

- ❑ Select the **Roc+** sub-function using the $\blacktriangle / \blacktriangledown$ keys.
- ❑ **Reconnect** DC+ lead on PV Safety probe (A 1384, (see Figure 5.3, - step 2).
- ❑ Press the **TEST** key to perform the measurement (double click for continuous measurement and later press to stop the measurement).
- ❑ After the measurement is finished wait until tested item is fully discharged.
- ❑ **Store** the result by pressing the **MEM** key (optional).

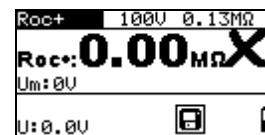

Figure 5.4: Examples of insulation resistance measurement result

Displayed results:

Roc+, Roc-.....Insulation resistance
 Um.....Test voltage – actual value
 U:..... Actual voltage on test inputs

5.2 Resistance of earth connection and equipotential bonding

The resistance measurement is performed in order to ensure that the protective measures against electric shock through earth connections and bondings are effective. Two sub-functions are available:

- R LOWΩ - Earth bond measurement according to EN 61557-4 (200 mA),
- CONTINUITY - Continuous resistance measurement performed with 7 mA.

See chapter 4.2 Function selection for instructions on key functionality.

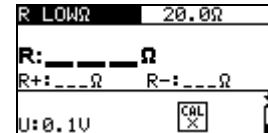

Figure 5.5: 200 mA RLOW Ω

Test parameters for resistance measurement

TEST	Resistance measurement sub-function [R LOWΩ, CONTINUITY]
Limit	Maximum resistance [OFF, 0.1 Ω ÷ 20.0 Ω]

Additional test parameter for Continuity sub-function

	Buzzer On (sound if resistance is lower than the set limit value) or Off
--	--

5.2.1 R LOWΩ, 200 mA resistance measurement

The resistance measurement is performed with automatic polarity reversal of the test voltage.

Connection for R LOWΩ measurement

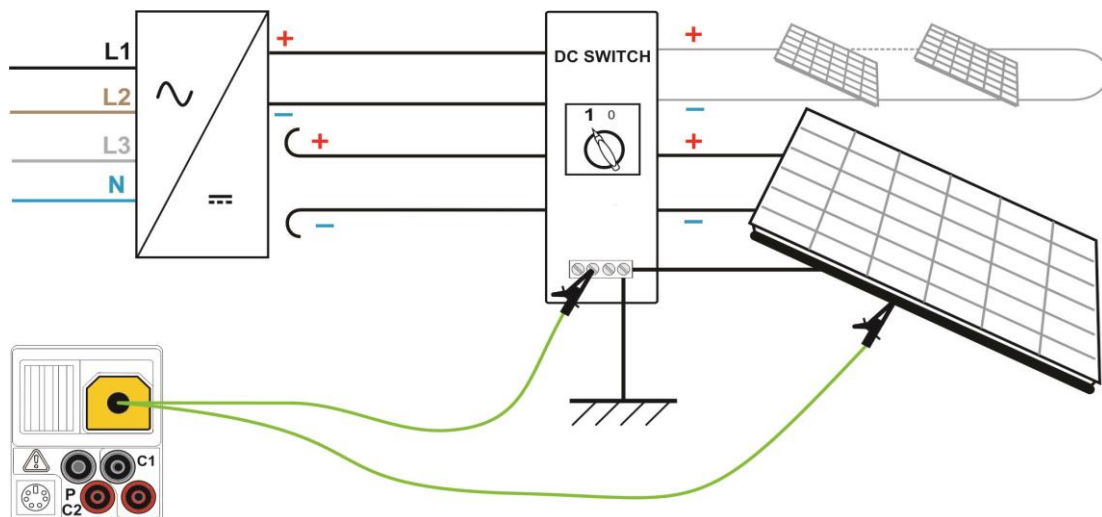

Figure 5.6: Connection for RLOW Ω test

R LOWΩ measurement procedure

- ❑ Select continuity function using the function selector keys.
- ❑ Set sub-function to **R LOWΩ** using \blacktriangle / \blacktriangledown keys.
- ❑ Enable and set **limit** (optional).
- ❑ **Connect** PV continuity test lead to the instrument.
- ❑ **Compensate** the test leads resistance (if necessary, see section 5.2.3).
- ❑ **Connect** the test leads to the appropriate PE wiring (see Figure 5.6).
- ❑ Press the **TEST** key to perform the measurement.
- ❑ After the measurement is finished **store** the result by pressing the **MEM** button (optional).

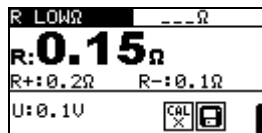

Figure 5.7: Example of RLOW Ω result

Displayed result:

- R.....R LOWΩ resistance
- R+.....result at positive polarity
- R-.....result at negative test polarity

- U:..... actual voltage on test inputs

5.2.2 Continuous resistance measurement with low current

In general, this function serves as standard Ω-meter with a low testing current. The measurement is performed continuously without polarity reversal. The function can also be applied for testing continuity of inductive components.

Connection for continuous resistance measurement

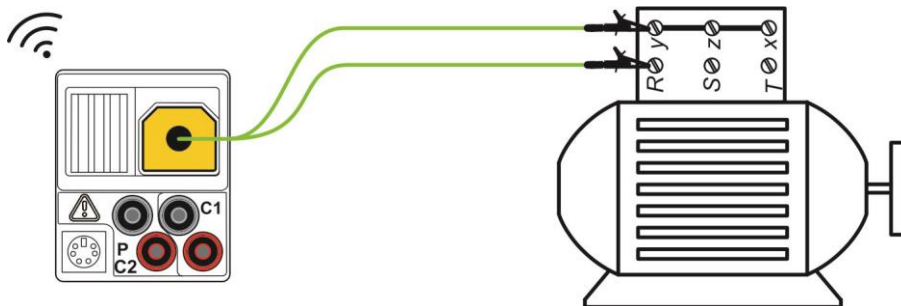

Figure 5.8: Example of Continuity test

Continuous resistance measurement procedure

- ❑ Select continuity function using the function selector keys.
- ❑ Set sub-function to **CONTINUITY** using \blacktriangle / \blacktriangledown keys.
- ❑ Enable and set the **limit** (optional).

- ❑ **Connect** PV continuity test lead to the instrument.
- ❑ **Compensate** test leads resistance (if necessary, see *section 5.2.3*).
- ❑ **Disconnect** from mains supply and discharge the object to be tested.
- ❑ **Connect** test leads to the tested object (see Figure 5.8).
- ❑ Press the **TEST** key to begin performing a continuous measurement.
- ❑ Press the **TEST** key to stop measurement.
- ❑ **Store** the result by pressing the **MEM** key (optional).



Figure 5.9: Example of continuous resistance measurement

Displayed result:

R:.....resistance

U:.....actual voltage on test inputs

5.2.3 Compensation of test leads resistance

This chapter describes how to compensate the test leads resistance in both continuity functions, R LOW Ω and CONTINUITY. Compensation is required to eliminate the influence of test leads resistance and the internal resistances of the instrument on the measured resistance. The lead compensation is therefore a very important feature to obtain correct result.



CAL symbol is displayed if the compensation was carried out successfully.

Circuits for compensating the resistance of test leads



Figure 5.10: Shorted test leads

Compensation of test leads resistance procedure

- ❑ Select **R LOW Ω** or **CONTINUITY** function.
- ❑ **Connect** Continuity PV test lead to the instrument and short the test leads together (see Figure 5.10).
- ❑ Press **TEST** to perform resistance measurement.
- ❑ Press the **CAL** key to compensate leads resistance.

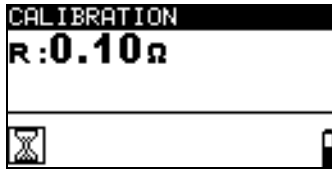



Figure 5.11: Results with old calibration value



Figure 5.12: Results with new calibration value

Note:

- The highest value for lead compensation is 5 Ω. If the resistance is higher the compensation value is set back to default value.
-  is displayed if no calibration value is stored.

5.3 PV inverter test

The test is intended to check proper operation of the PV inverter. Following functions are supported:

- Measuring of DC values at inverter’s input and AC values at inverter’s output.
- Calculation of the efficiency of the inverter.

With the EurotestPV Lite instrument one DC and one AC signal can be measured at the same time.

For 3-phase inverters one DC and three AC signals can be measured at the same time with a combination of a Metrel Powermeter and the EurotestPV Lite instrument. During the measurement the Power meter and EurotestPV Lite instrument must be connected via serial cable or Bluetooth link. At the end of the measurement the results from Powermeter are sent to and displayed on the EurotestPV Lite instrument.

See chapter 4.2 Function selection for instructions on key functionality.

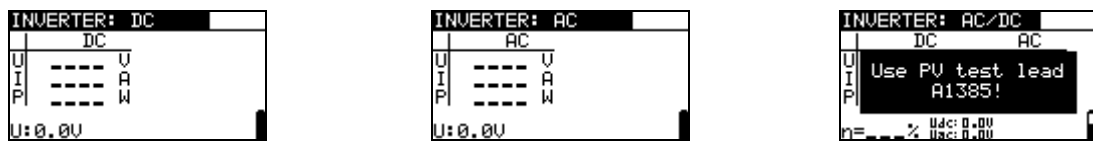

Figure 5.13: Examples of PV inverter test starting screens



Figure 5.14: Examples of PV inverter test starting screens – three phase a.c.output

Settings and parameters for PV inverter test

Input	Inputs/ Outputs being measured [AC, DC, AC/DC, AC3, AC3/DC]
-------	--

Connection for PV inverter measurement

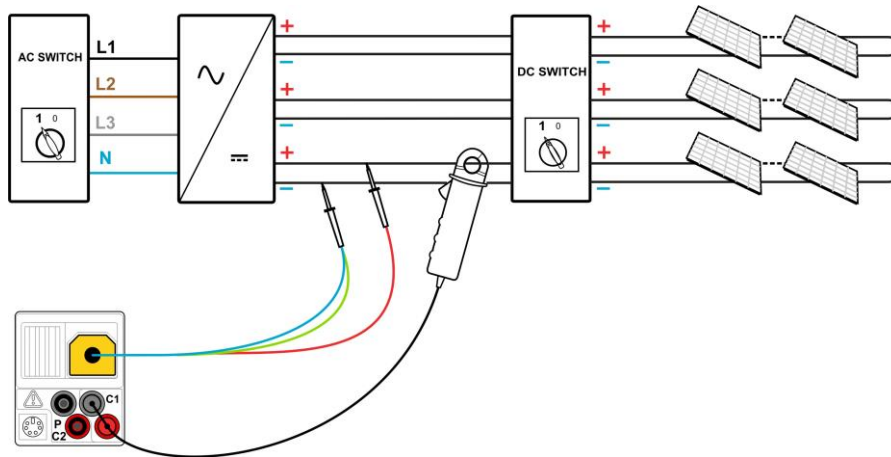

Figure 5.15: Connection with universal PV test lead – DC side

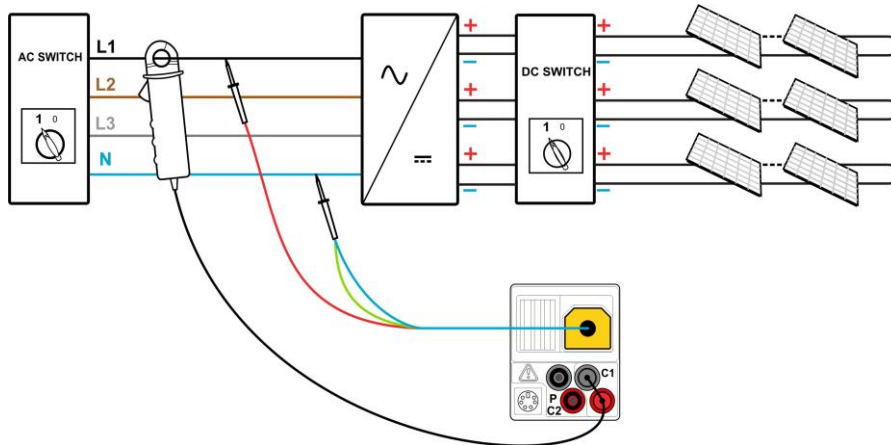

Figure 5.16: Connection with universal PV test lead – AC side

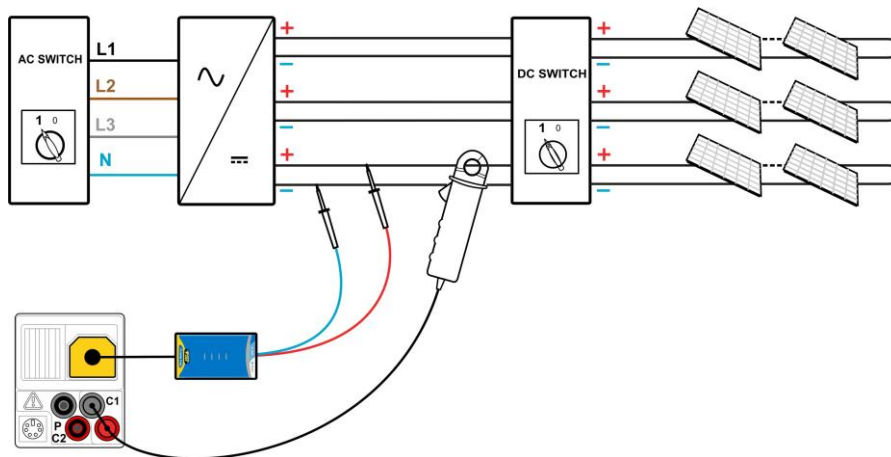

Figure 5.17: Connection with PV Safety Probe - DC side

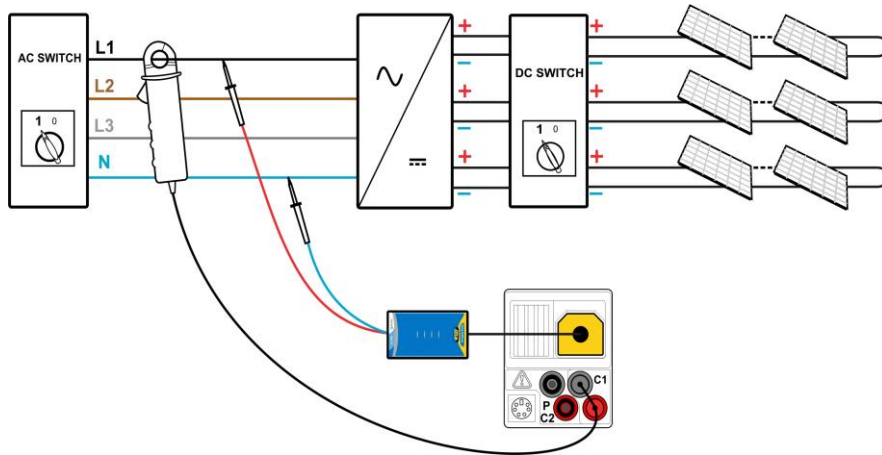

Figure 5.18: Connection with PV Safety Probe - AC side

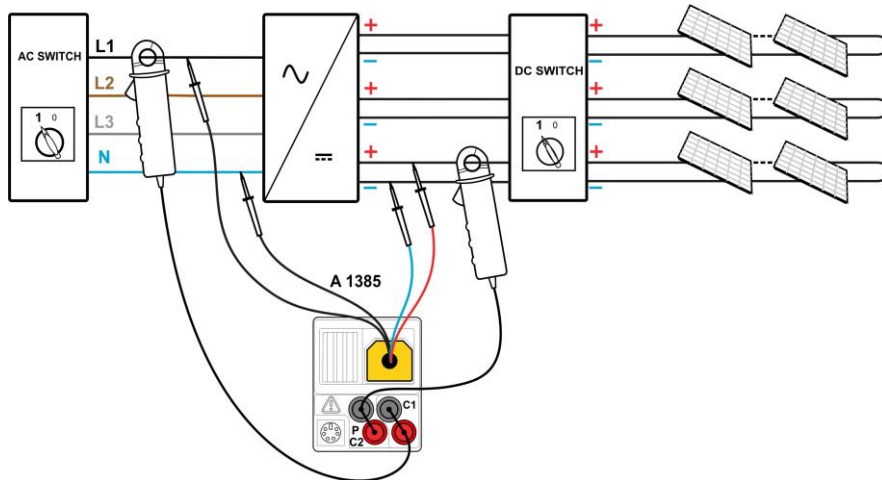

Figure 5.19: Connection with A 1385 - AC and DC sides

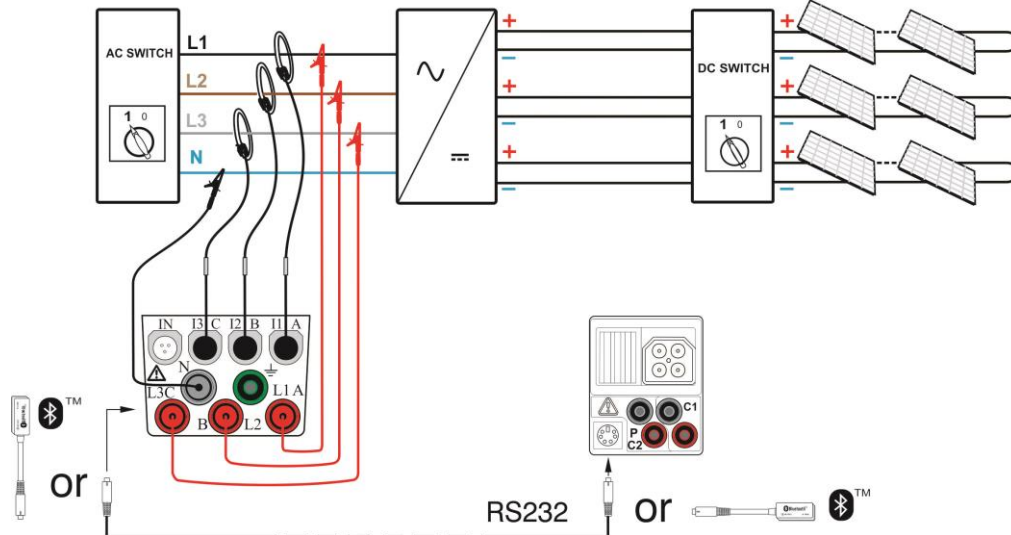

Figure 5.20: Connection to Metrel Powermeter for 3 phase AC measurements

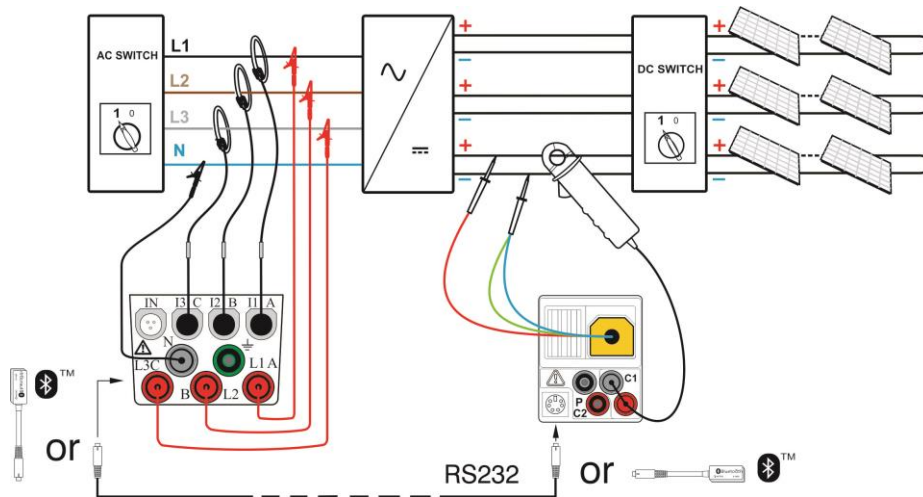

Figure 5.21: Connection in AC3 / DC sub-function using universal PV test lead

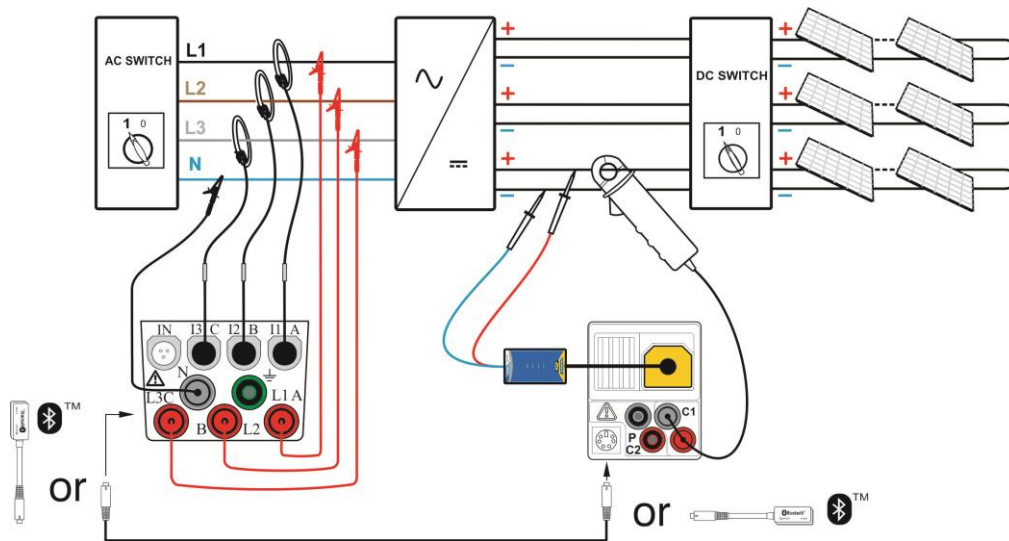

Figure 5.22: Connection in AC3 / DC sub-function using PV safety probe

PV inverter test procedure (with EurotestPV Lite instrument)

- ❑ Select **INVERTER** sub-function using the function selector keys and \wedge/\vee keys.
- ❑ **Connect** PV safety probe and current clamp to the instrument (see figures 5.15 to 5.18) or
- ❑ **Connect** PV test lead A 1385 and current clamps to the instrument (see figure 5.19)
- ❑ **Connect** accessories to the PV system (see figures 5.15 to 5.19).
- ❑ Check input voltages.
- ❑ Press the **TEST** key to perform the measurement.
- ❑ **Store** the result by pressing the **MEM** key (optional).

PV inverter test procedure (with EurotestPV Lite instrument and Metrel Powermeter)

Note:

- The Communication settings of Powermeter must be following:
 Source = RS232
 Baud Rate = 9600

- Select **INVERTER** sub-function using the function selector keys and Δ/∇ keys.
- Be sure that the EurotestPV Lite instrument and Powermeter are connected via serial cable or Bluetooth.
- **Connect** universal PV test lead or PV safety probe and DC current clamp to the EurotestPV Lite instrument (see figures 5.20 to 5.22).
- **Connect** voltage test leads and AC current clamps to the Powermeter.
- **Connect** voltage test leads to L1, L2, L3 and N at the output side of the inverter (see figures 5.20 to 5.22).
- **Connect** accessories to the PV system (see figures 5.20 and 5.22).
- Check input voltages on the instrument and measurement results on the Powermeter (best to be in **Power measurements** menu).
- Press the **TEST** key to perform the measurement. Results from both instruments are displayed on the EurotestPV Lite screen. A.C. measurement results in detail are displayed on Powermeter also.
- **Store** the result by pressing the **MEM** key (optional).



Figure 5.23: Examples of PV inverter test results screens - 1 phase a.c. output



Figure 5.24: Examples of PV inverter test results screens - 3 phase a.c. output

POWER METER				
	L1	L2	L3	Total
P	10.75	10.92	22.06	-0.39 kW
Q	18.69	-18.72	0.67	0.64 kVar
S	21.56	21.67	22.07	0.75 kVA
pf	+0.49i	-0.50c	-0.99c	-0.52c
dpf	+0.49i	-0.50c	-1.00c	
U	234.5	235.8	235.8	V
I	91.93	91.90	93.61	A
HOLD 123.40				

Figure 5.25: Example of Powermeter result screen - 3 phase a.c. output

Displayed results for PV inverter test:

DC column:

- U.....measured voltage at the input of the inverter
- I.....measured current at the input of the inverter
- P.....measured power at the input of the inverter

AC (3 phase power) column

- Pt.....measured total power at the output of the inverter
- P1.....measured power of phase 1 at the output of the inverter
- P2.....measured power of phase 2 at the output of the inverter

P3.....measured power of phase 3 at the output of the inverter

ηcalculated efficiency of the inverter

U:.....actual voltage on test inputs

Notes:

- With one current clamp the complete test can be performed in two steps. Input should be set to **DC** and **AC** separately.
- For the INVERTER AC/DC test fused test lead A 1385 must be used!
- For more information about measuring and setup of the Metrel Powermeter refer to Metrel Powermeter's instruction manual. Contact Metrel or distributor for detailed information which Metrel Powermeters are suitable for this measurement.

5.4 PV panel test

PV panel test is intended to check proper operation of PV panels. Following functions are supported:

- measuring of output voltage, current and power of PV panel,
- comparison of measured PV output values (MEAS values) and calculated nominal data (STC values)
- comparison of measured PV output power (Pmeas) and theoretical output power (Ptheo)

The PV panel test results are divided into three screens. See chapter 4.2 Function selection for instructions on key functionality.

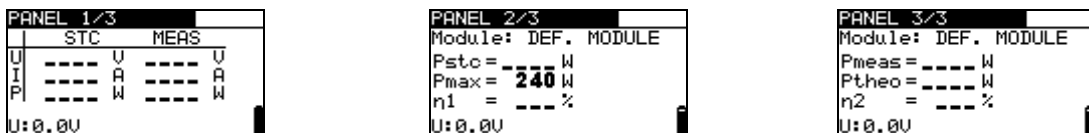

Figure 5.26: PV module test starting screens

Connection for PV panel test

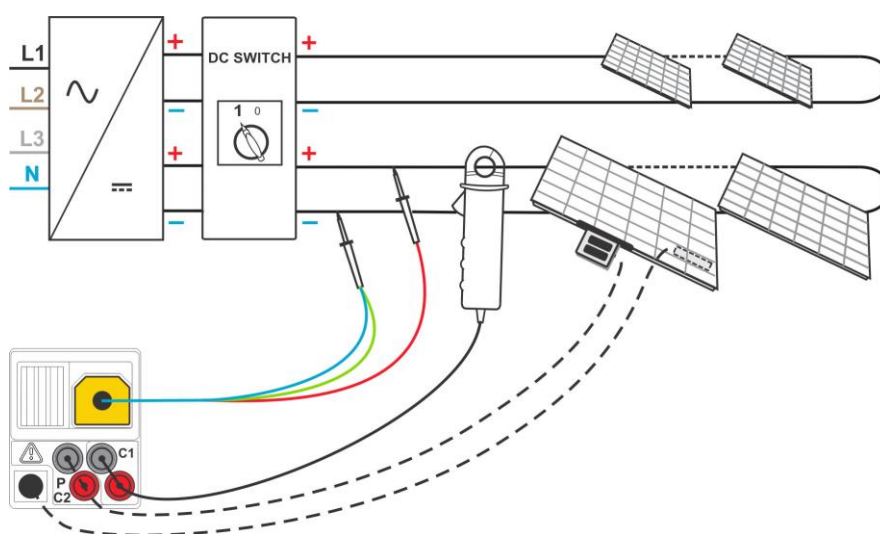

Figure 5.27: Connection with universal PV test lead

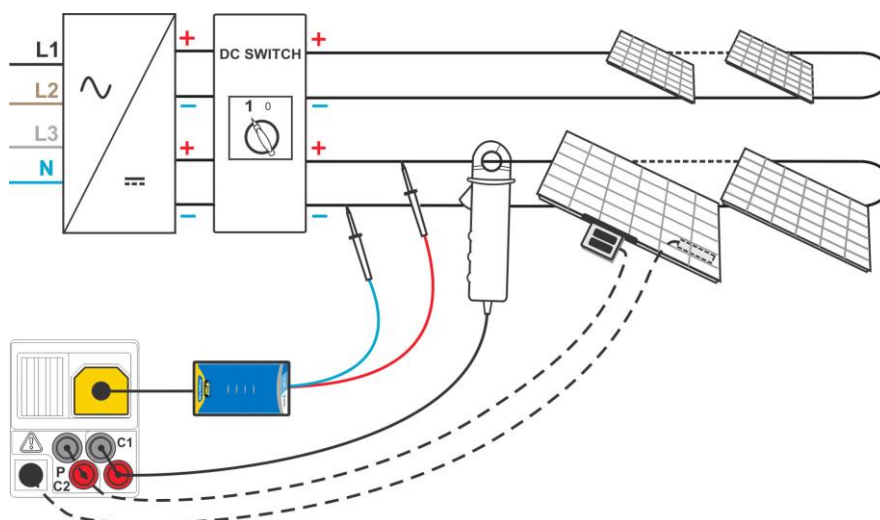

Figure 5.28: Connection with PV safety probe

PV panel test procedure

- ❑ Select **PANEL** sub-function using the function selector keys.
- ❑ **Connect** universal PV test lead / PV safety probe, current clamp(s) and sensors to the instrument (see **Figure 5.27** and **Figure 5.28**).
- ❑ **Connect** accessories to the PV system to be tested (see **Figure 5.27** and **Figure 5.28**).
- ❑ Check input voltage.
- ❑ Press the **TEST** key to perform the test.
- ❑ **Store** the result by pressing the **MEM** key (optional).

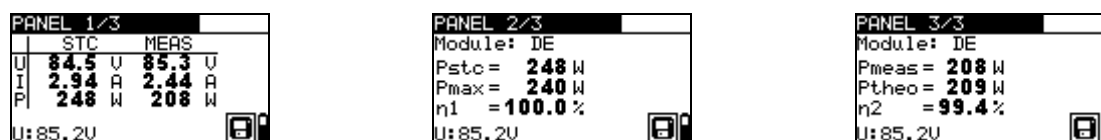

Figure 5.29: Examples of PV measurement results

Displayed results are:

MEAS column

U.....measured output voltage of the panel

I.....measured output current of the panel

P.....measured output power of the panel

STC column

U.....calculated output voltage of the panel at STC

I.....calculated output current of the panel at STC

P.....calculated output power of the panel at STC

Pstc.....measured output power of the panel at STC

Pmax..... nominal output power of the panel at STC

η1.....efficiency of the panel at STC

Pmeas... .measured output power of the panel at momentary conditions

Ptheo.....calculated theoretical output power of the panel at momentary conditions

η2..... calculated efficiency of the panel at momentary conditions (simplified method, see appendix E)

U:.....actual voltage on test inputs

Notes:

- ❑ Before starting the PV measurements settings of PV module type and PV test parameters should be checked.
- ❑ For calculation of STC results PV module type, PV test parameters, Uoc, Isc, Irr and Tcell values must be measured or be entered manually before the test. The results in ENV. and Uoc/Isc menus are considered. If there are no results in Uo/Isc menu the instrument will consider results in I-V menu.
- ❑ The Uoc, Isc, Irr and T measurements should be carried out immediately before the PANEL test. Environmental conditions must be stable during the tests.
- ❑ For best results the A 1378 PV Remote Unit should be used.

5.5 Measuring of environmental parameters

Temperature and solar irradiance values must be known for:

- ❑ calculation of nominal values at standard test conditions (STC),
- ❑ checking that environmental conditions are suitable for carrying out the PV tests.

The parameters can be measured or entered manually. The probes can be connected to the instrument or to the PV remote unit A 1378.

See chapter 4.2 Function selection for instructions on key functionality.

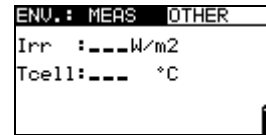

Figure 5.30: Environmental parameters screen

Test parameters for measuring / setting of environmental parameters

INPUT	Input of environmental data [MEAS, MANUAL]
OTHER	Shortcut to SOLAR SETTINGS menu

Connection for measuring of environmental parameters

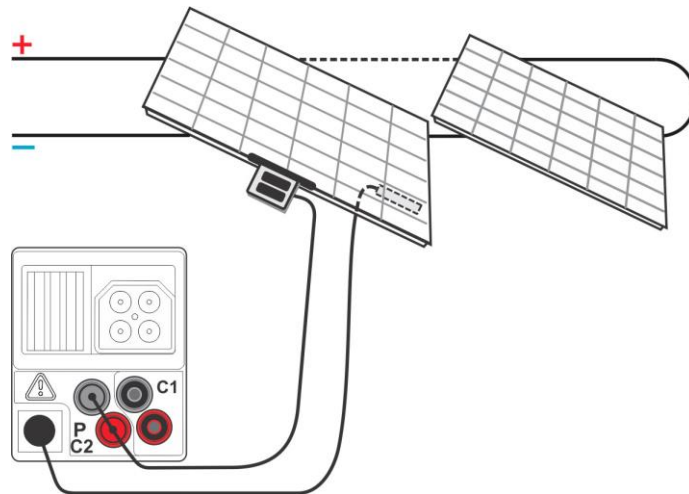

Figure 5.31: Measurement of environmental parameters

Procedure for measuring of environmental parameters

- ❑ Select **ENV.** function and **MEAS** sub-function using the function selector keys and \blacktriangle / \blacktriangledown keys.
- ❑ **Connect** environmental probes to the instrument (see **Figure 5.31**).
- ❑ **Connect** probes to the item to be tested (see **Figure 5.31**).
- ❑ Press the **TEST** key to perform the measurement.
- ❑ **Store** the result by pressing the **MEM** key (optional).

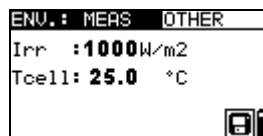

Figure 5.32: Example of measured results

Displayed results for environmental parameters:

- Irr.....solar irradiance
- Tamb or Tcell.... temperature of ambient or PV cells

Note:

- ❑ If the Irradiance result is lower than the set minimal value Irr min the STC results will not be calculated (message **Irr<Irr min!** is displayed).

Procedure for manual entering of environmental parameters

If the data is measured with other measuring equipment they can be entered manually. Select **ENV.** function and **MANUAL** sub-function using the function selector keys and Up/Down keys.

Keys:

TEST	Enters menu for manual setting of environmental parameters. Enters menu for changing selected parameter. Confirms set value of parameter.
▲ / ▼	Selects environmental parameter. Selects value of parameter.
Function selector	Exits environmental menu and select PV measurement.
ESC	Exits to main menu. Exits menu for manual setting of environmental parameters. Exits menu for changing selected parameter without changes.

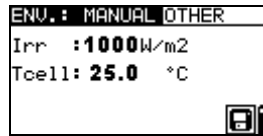

Figure 5.33: Example of manually entered results

Displayed results (Irr, Tamb or Tcell are the same as if measured.

Note:

- ❑ Environmental parameters are cleared when the instrument is switched Off.
- ❑ The environmental parameters menu is accessible in Single test and Autotest operating modes.

5.5.1 Operation with A 1378 PV Remote Unit

See PV Remote Unit User Manual.

5.6 Uoc / Isc measurement

The Uoc / Isc test is intended to check if protection devices in the d.c. part of the PV installation are effective. The measured data can be calculated to nominal data (STC values).

See chapter 4.2 Function selection for instructions on key functionality.

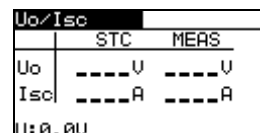

Figure 5.34: Uoc / Isc test

Connection for Uoc / Isc measurement

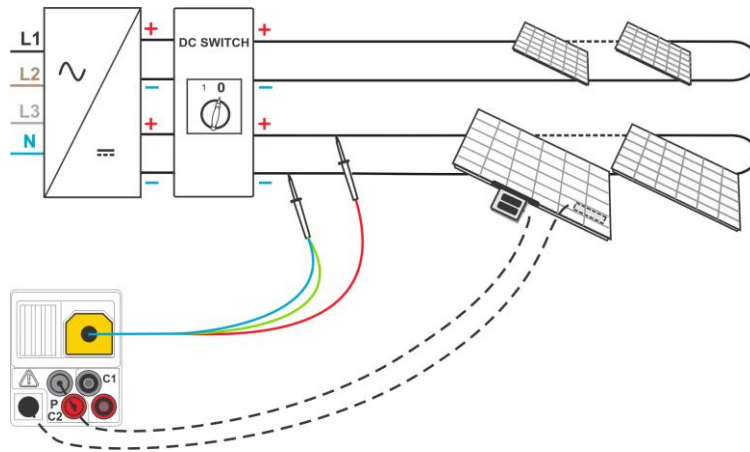

Figure 5.35: Connection with universal PV test lead

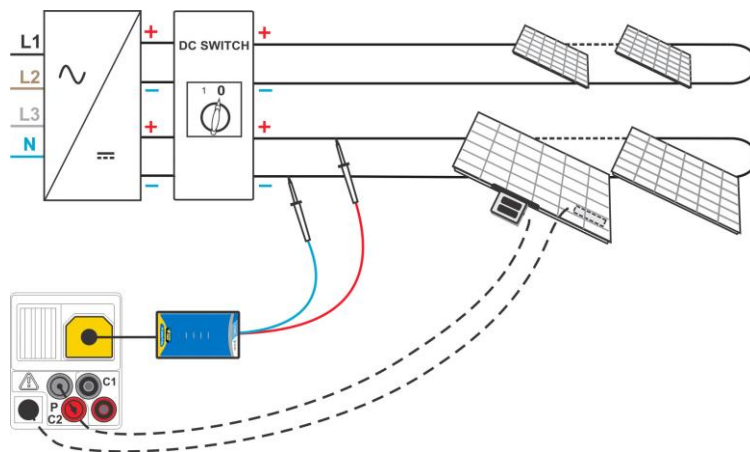

Figure 5.36: Connection with PV safety probe

Uoc / Isc measurement procedure

- ❑ Select **Uoc / Isc** sub-function using the function selector keys and \blacktriangle / \blacktriangledown keys.
- ❑ **Connect** universal PV test lead / PV safety probe and sensors (optional) to the instrument (see **Figure 5.35** and **Figure 5.36**).
- ❑ **Connect** accessories to the item to be tested (see **Figure 5.35** and **Figure 5.36**).
- ❑ Check value and polarity of input voltage.
- ❑ Press the **TEST** key to perform the measurement.
- ❑ **Store** the result by pressing the **MEM** key (optional).

Uo/Isc		STC	MEAS
Uo		112V	110V
Isc		5.29A	4.93A
U: 4.5V			

Figure 5.37: Example of Uoc / Isc measurement results

Displayed results for Uoc / Isc measurement:

MEAS column

Uoc.....measured open voltage of the panel

Isc.....measured short circuit current of the panel

STC column

Uoc.....calculated open voltage at STC

Isc.....calculated short circuit current at STC

U:.....actual voltage on test inputs

Notes:

- ❑ Before starting the PV measurements settings of PV module type and PV test parameters should be checked.
- ❑ For calculation of STC results correct PV module type, PV test parameters, Irr and Tcell values must be measured or be entered manually before the test. The Irr and T results in ENV. menu are considered. Refer to Appendix E for further information.
- ❑ The Irr and T measurements should be carried out immediately before the Uoc / Isc test. Environmental conditions must be stable during the tests.
- ❑ For best results PV remote unit A 1378 should be used.

5.7 I / V curve measurement

The I / V curve measurement is used to check correct operation of the PV panels. Different problems on PV panels (failure of a part of the PV panel / string, dirt, shadow etc.) can be found.

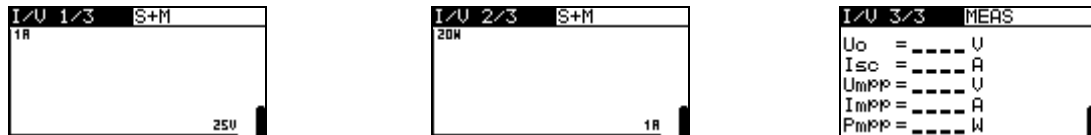

Figure 5.38: I / V curve starting screens

The data to be measured is divided into three screens. See chapter 4.2 Function selection for instructions on key functionality.

Settings parameters for I / V curve measurement

1/3	Number of screen.
STC	Results (STC, measured, both) to be displayed.

Connection for the I / V curve measurement

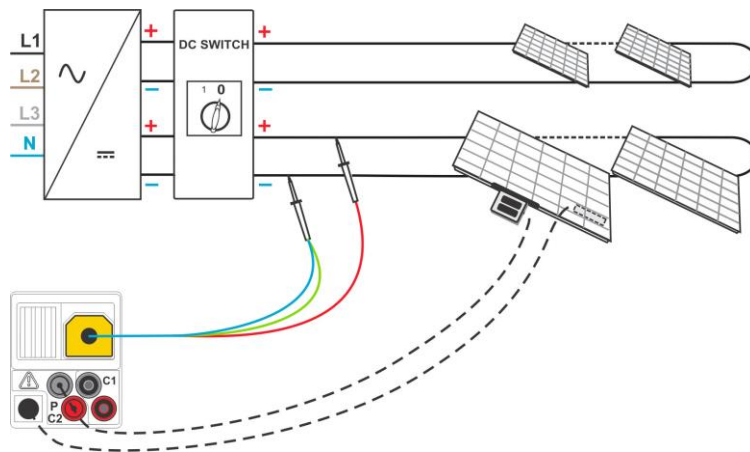

Figure 5.39: Connection with universal PV test lead

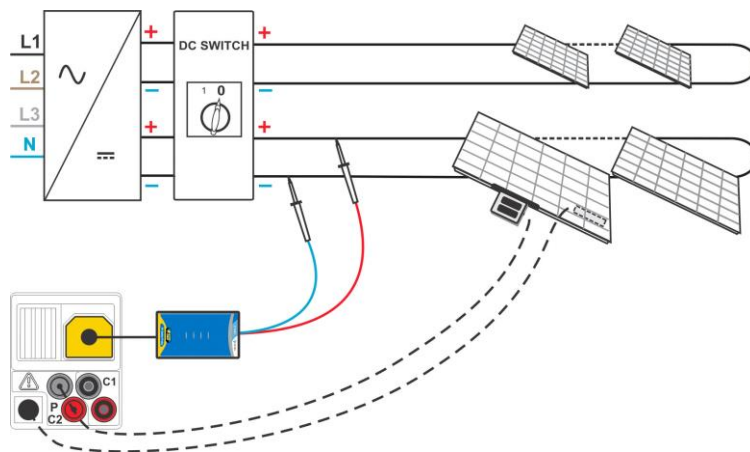

Figure 5.40: Connections with PV safety probe

I / V curve measurement procedure

- ❑ Select **I/V** sub-function using the function selector keys and $\blacktriangle / \blacktriangledown$ keys.
- ❑ Check or set PV module and PV testing parameters and limits (optional).
- ❑ **Connect** universal PV test lead / PV safety probe to the instrument.
- ❑ **Connect** environmental probes to the instrument (optional).
- ❑ **Connect** accessories to the item to be tested (see **Figure 5.39** and **Figure 5.40**).
- ❑ Press the **TEST** key to perform the measurement.
- ❑ **Store** the result by pressing the **MEM** key (optional).

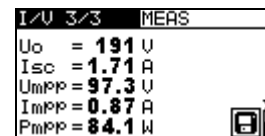
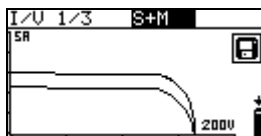

Figure 5.41: Example of I / V curve results

Displayed results for I / V curve test:

- Uoc.....measured / STC open circuit voltage of the panel
- Isc.....measured / STC short circuit current of the panel
- Umpp.....measured / STC voltage at maximal power point
- Imppmeasured / STC current at maximal power point
- Pmpp.....measured / STC maximal output power of the panel

Notes:

- ❑ Before starting the PV measurements settings of PV module type and PV test parameters should be checked.
- ❑ For calculation of STC results correct PV module type, PV test parameters, Irr and Tcell values must be measured or be entered manually before the test. The Irr. and T results in ENV. menu are considered. Refer to Appendix E for further information.
- ❑ The Irr. and T measurements should be carried out immediately before the I / V curve test. Environmental conditions must be stable during the tests.
- ❑ For best results PV remote unit A 1378 should be used.

5.8 Automatic measurement procedure according to IEC/ EN 62446 (Auto)

The Auto function is intended to perform a complete test of PV panel, string, array:

- ❑ insulation resistance between positive output and earth
- ❑ insulation resistance between negative output and earth
- ❑ calculated insulation resistance between shorted both outputs and earth
- ❑ open circuit voltage (measured and STC)
- ❑ short circuit current (measured and STC)

The test is carried out in one set of automatic tests, guided by the instrument.

The Auto function test results are divided into two screens. See chapter 4.2 Function selection for instructions on key functionality.

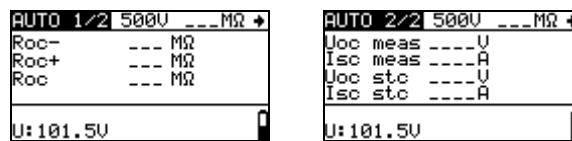

Figure 5.42: Automatic measurement starting screens

Test parameters for automatic measurement

Uiso	Test voltage [50 V, 100 V, 250 V, 500 V, 1000 V]
Limit	Minimum insulation resistance [OFF, 0.01 MΩ ÷ 200 MΩ]
Time	Test duration [OFF, 5 s ÷ 60 s]

Test circuits for automatic measurement

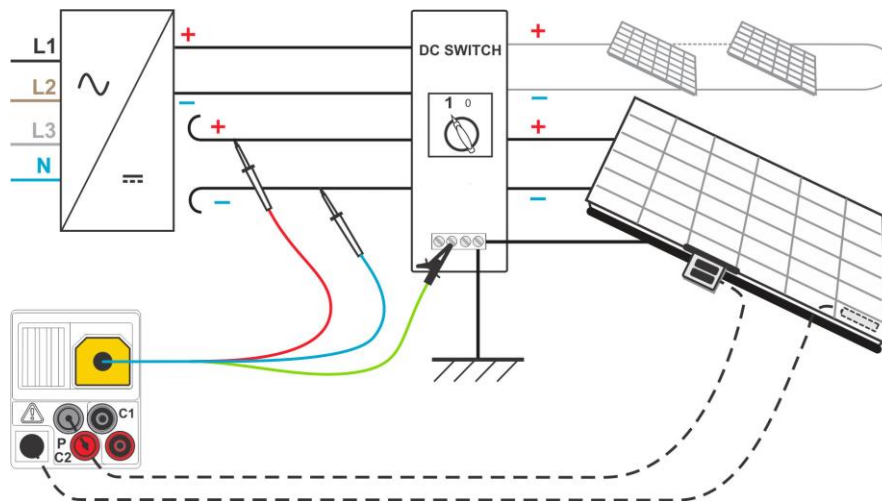

Figure 5.43: Connection for automatic measurement with universal PV test lead

Automatic measurement procedure

- ❑ Select AUTOTEST mode from main menu.
- ❑ Set environmental parameters, module and measuring settings (optional).
- ❑ Select the **AUTO** sub-function using the function selector keys.
- ❑ Set the required insulation **test voltage**.
- ❑ Enable and set **limit** value (optional).
- ❑ **Connect** universal PV test cable to the instrument (see **Figure 5.43**).
- ❑ **Connect** environmental probes to the instrument (optional).
- ❑ **Connect** accessories to the PV system (see **Figure 5.43**).
- ❑ Press the **TEST** key to perform the measurement.
- ❑ After the measurement is finished wait until tested item is fully discharged.
- ❑ **Store** the result by pressing the **MEM** key (optional).

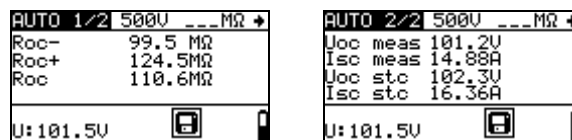

Figure 5.44: Example of automatic measurement result

Displayed results:

- Roc+.....insulation resistance between array negative and earth
- Roc-insulation resistance between array positive and earth
- Roc.....calculated insulation resistance between shorted both outputs and earth
- Uoc meas.....measured open voltage of the panel
- Isc meas.....measured short circuit current of the panel
- Uoc stccalculated open voltage at STC
- Isc stc.....calculated short circuit current at STC
- U:actual voltage on test inputs

Notes:

- Before starting the PV measurements settings of PV module type and PV test parameters should be checked.
- For calculation of STC results correct PV module type, PV test parameters, Irr and Tcell values must be measured or be entered manually before the test. The Irr and T results in ENV. menu are considered. Refer to Appendix E for further information.
- The Irr and T measurements should be carried out immediately before the Uoc / Isc test. Environmental conditions must be stable during the tests.
- For best results PV remote unit A 1378 should be used
- Roc is a calculated value based on measured Roc+ and Roc-. Roc+ and Roc- are measured according to method 1 in the IEC 62446 standard. The calculated value is based on the electrical substitute model of PV modules and is in general the same or closes to the insulation resistance that would be measured according to method 2 in the IEC 62446 standard.

5.9 Measurement of cell temperature before test

The standard IEC 61829 recommends procedure for choosing and recording appropriate conditions for measurement. One of the recommendations is that the temperature of the PV array must be equilibrated before the test. In combination with the PV remote unit A 1378 the instrument enables to store the measured cell temperatures 0 min, 5 min, 10 min and 15 minutes before PV tests (I/ V curve measurement, Uoc/Isc test, PV panel test and Auto test).

The cell temperature should be measured with A1378 before the PV test. After synchronization of results between the instrument and A1378 the instrument enables to add temperature values before the test to stored I/ V curve, Uoc/Isc, PV panel test and Auto test results.

The results can be viewed in recall memory screens (see 8.4 *Recalling test results* for more information).

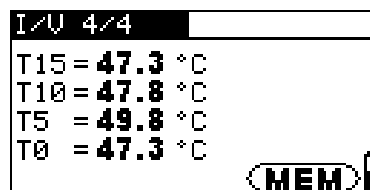

Figure 5.45: Example of cell temperature before test result screen

Displayed results:

T15.....cell temperature 15 minutes before the PV test
 T10.....cell temperature 10 minutes before the PV test
 T5.....cell temperature 5 minutes before the PV test
 T0.....cell temperature at the moment before the PV test

6 Data handling

6.1 Memory organization

Measurement results together with all relevant parameters can be stored in the instrument's memory. After the measurement is completed, results can be stored to the flash memory of the instrument, together with the sub-results and function parameters.

6.2 Data structure

The instrument's memory place is divided into 4 levels each containing 199 locations. The number of measurements that can be stored into one location is not limited.

The **data structure field** describes the location of the measurement (which object, inverter, string, panel) and where can be accessed.

In the **measurement field** there is information about type and number of measurements that belong to the selected structure element (object and inverter and string and panel).

The main advantages of this system are:

- Test results can be organized and grouped in a structured manner that reflects the structure of typical PV system.
- Customized names of data structure elements can be uploaded from EurolinkPRO, or Metrel ES Manager PCSW.
- Simple browsing through structure and results.
- Test reports can be created with no or little modifications after downloading results to a PC.

```

RECALL RESULTS
[OBJ]OBJECT1
[INV]INVERTER 007
[STR]STRING 001
[PAN]PANEL 001
> No. : 3/3
RISO +
  
```

Figure 6.1: Data structure and measurement fields

Data structure field

RECALL RESULTS	Memory operation menu
[OBJ]OBJECT 001 [INV]INVERTER 007 [STR]STRING 001 [PAN]PANEL 001	Data structure field
[OBJ]OBJECT 001	<ul style="list-style-type: none"> □ 1st level: OBJECT: Default location name (object and its successive number). 001: No. of selected element.
[INV]INVERTER 001	<ul style="list-style-type: none"> □ 2nd level: INVERTER: Default location name (inverter and its successive number). 001: No. of selected element.
[STR]STRING 003	<ul style="list-style-type: none"> □ 3rd level: STRING: Default location name (string and its successive number). 003: No. of selected element.

[PAN]PANEL 001	□ 4th level: PANEL: Default location name (panel and its successive number). 001: No. of selected element.
No.: 20 [112]	No. of measurements in selected location [No. of measurements in selected location and its sub-locations]
Measurement field	
RISO +	Type of stored measurement in the selected location.
No.: 3/3	No. of selected test result / No. of all stored test results in selected location.

6.3 Storing test results

After the completion of a test the results and parameters are ready for storing (💾 icon is displayed in the information field). By pressing the **MEM** key, the user can store the results.



Figure 6.2: Save test menu

Memory free: 99.6% Memory available for storing results.

Keys in save test menu - data structure field:

TAB	Selects the location element (Object / Inverter / String / Panel).
▲ / ▼	Selects number of selected location element (1 to 199).
MEM	Saves test results to the selected location and returns to the measuring function screen.
ESC / TEST / Function selector	Exits back to measuring function screen without save.

Notes:

- ❑ The instrument offers to store the result to the last selected location by default.
- ❑ If the measurement is to be stored to the same location as the previous one just press the **MEM** key twice.

6.4 Recalling test results

Press the **MEM** key in a main function menu when there is no result available for storing or select **MEMORY** in the **SETTINGS** menu.

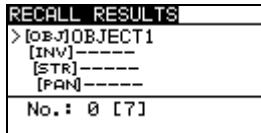

Figure 6.3: Recall menu - installation structure field selected



Figure 6.4: Recall menu - measurements field selected

Keys in recall memory menu (installation structure field selected):

TAB	Selects the location element (Object / Inverter / String / Panel).
▲ / ▼	Selects number of selected location element (1 to 199).
Function selector / ESC	Exits back to main function menu.
TEST	Enters measurements field.

Keys in recall memory menu (measurements field):

▲ / ▼	Selects the stored measurement.
TAB / ESC	Returns to installation structure field.
Function selector	Exits back to main function menu.
TEST	View selected measurement results.



Figure 6.5: Example of recalled measurement result

Keys in recall memory menu (measurement results are displayed)

▲ / ▼	Displays measurement results stored in selected location.
HELP	Toggle between multiple result screens.
MEM / ESC	Returns to measurements field.
Function selector / TEST	Exits back to main function menu.

6.5 Clearing stored data

6.5.1 Clearing complete memory content

Select **CLEAR ALL MEMORY** in **MEMORY** menu. A warning will be displayed.

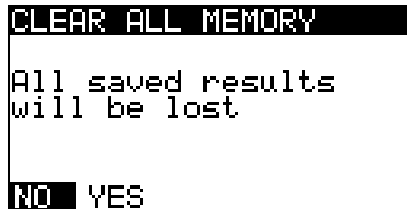

Figure 6.6: Clear all memory

Keys in clear all memory menu

TEST	Confirms clearing of complete memory content (YES must be selected with ▲ / ▼ keys).
ESC /	Exits back to memory menu without changes.
Function selector	Exits back to main menu without changes.

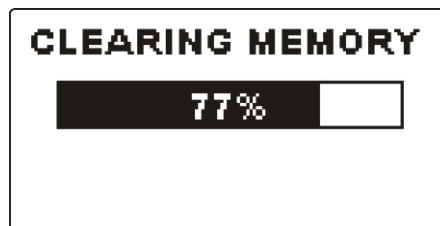

Figure 6.7: Clearing memory in progress

6.5.2 Clearing measurement(s) in selected location

Select **DELETE RESULTS** in **MEMORY** menu.

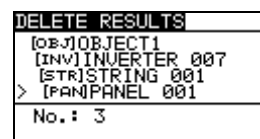
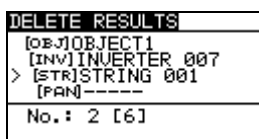

Figure 6.8: Clear measurements menu (data structure field selected)

Keys in delete results menu (installation structure field selected):

TAB	Selects the location element (Object / Inverter / String / Panel).
▲ / ▼	Selects number of selected location element (1 to 199).
Function selector	Exits back to main menu.
ESC	Exits back to memory menu.
TEST	Enters dialog box for deleting all measurements in selected location and its sub-locations.

Keys in dialog for confirmation to clear results in selected location:

TEST	Deletes all results in selected location.
-------------	---

MEM / ESC	Exits back to delete results menu (installation structure field selected) without changes.
Function selector	Exits back to main menu without changes.

6.5.3 Clearing individual measurements

Select **DELETE RESULTS** in **MEMORY** menu.

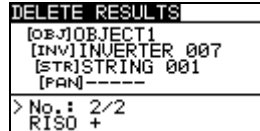

Figure 6.9: Menu for clearing individual measurement (installation structure field selected)

Keys in delete results menu (installation structure field selected):

TAB	Selects the location element (Object / Inverter / String / Panel).
▲ / ▼	Selects number of selected location element (1 to 199).
Function selector	Exits back to main menu.
ESC	Exits back to memory menu.
MEM	Enters measurements field for deleting individual measurements.

Keys in delete results menu (measurements field selected):

▲ / ▼	Selects measurement.
TEST	Opens dialog box for confirmation to clear selected measurement.
TAB / ESC	Returns to installation structure field.
Function selector	Exits back to main menu without changes.

Keys in dialog for confirmation to clear selected result(s):

TEST	Deletes selected measurement result.
MEM / TAB / ESC	Exits back to measurements field without changes.
Function selector	Exits back to main menu without changes.

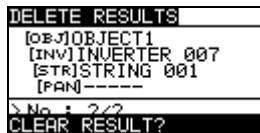

Figure 6.10: Dialog for confirmation

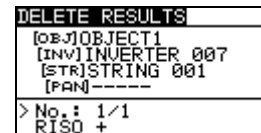

Figure 6.11: Display after measurement was cleared

6.5.4 Renaming installation structure elements (upload from PC)

Default installation structure elements are “Object”, “Inverter”, “String” and “Panel”. In the PCSW package Eurolink-PRO, or Metrel ES Manager, default names can be changed with customized names that corresponds the installation under test. Refer to PCSW Eurolink-PRO HELP or Metrel ES Manager Help, for information how to upload customized installation names to the instrument.

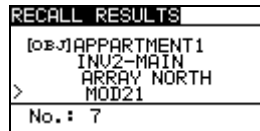

Figure 6.12: Example of menu with customized PV installation structure names

6.5.5 Renaming installation structure elements with serial barcode reader or RFID reader

Default installation structure elements are “Object”, “Inverter”, “String” and “Panel”. When the instrument is in the Save results menu location ID can be scanned from a barcode label with the barcode reader or can be read from a RFID tag with the RFID reader.

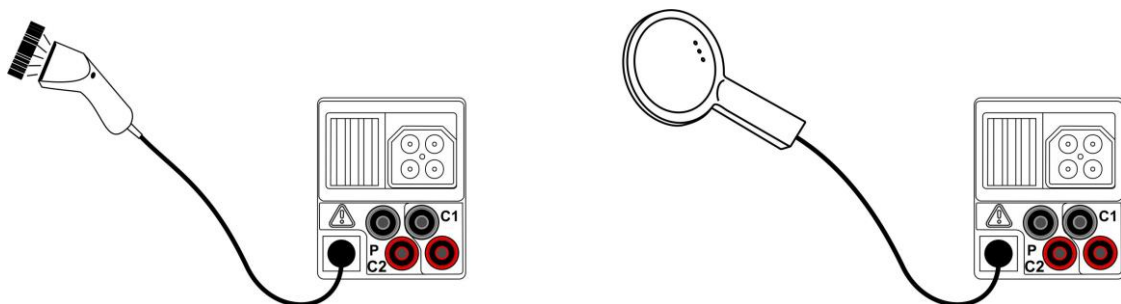

Figure 6.13: Connection of the barcode reader and RFID reader

How to change the name of memory location

- ❑ Connect the barcode reader or RFID reader to the instrument.
- ❑ Make sure that RS232 is selected in Communication menu.
- ❑ In Save menu select memory location to be renamed.
- ❑ A new location name (scanned from a barcode label or a RFID tag) will be accepted by the instrument. A successful receive of a barcode or RFID tag is confirmed by two short confirmation beeps.

Note:

- ❑ Use only barcode readers and RFID readers delivered by Metrel or authorized distributor.

6.6 Communication

There are two communication interfaces available on the instrument: USB or RS 232. With the optional Bluetooth dongle A 1436 the instrument can communicate via Bluetooth too.

6.6.1 USB and RS232 communication

The instrument automatically selects the communication mode according to detected interface. USB interface has priority.

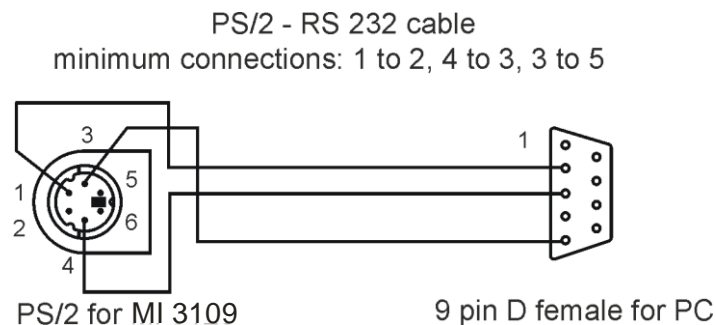

Figure 6.14: Interface connection for data transfer over PC COM port

How to configure a USB link between instrument and PC

- ❑ Connect a PC USB port to the instrument USB connector using the USB interface cable.
- ❑ Switch **on** the PC and the instrument.
- ❑ **Run** the *EuroLinkPRO* program or Metrel ES Manager.
- ❑ The PC and the instrument will automatically recognize each other.
- ❑ The instrument is prepared to communicate with the PC.

How to configure a RS232 link between instrument and PC

- ❑ Connect a PC COM port to the instrument PS/2 connector using the PS/2 - RS232 serial communication cable;
- ❑ Switch **on** the PC and the instrument.
- ❑ Set communication settings to RS232.
- ❑ **Run** the *EuroLinkPRO* program or Metrel ES Manager.
- ❑ Set COM port and baud rate.
- ❑ The instrument is prepared to communicate with the PC.

The program *EuroLinkPRO* is a PC software running on Windows XP, Windows Vista, Windows 7, Windows 8, and Windows 10. Read the file README_EuroLink.txt on CD for instructions about installing and running the program.

Metrel ES Manager is a PC software running on Windows 10 and Windows 11.

Notes:

- ❑ USB drivers should be installed on PC before using the USB interface. Refer to USB installation instructions available on installation CD.
- ❑ The RS232 port supports other services too (for example upgrading the instrument, connections of sensors, adapters, etc).

6.6.2 Bluetooth communication

How to configure a Bluetooth link between instrument and PC

For Bluetooth communication with PC a Standard Serial Port over Bluetooth link for Bluetooth dongle A 1436 must be configured first.

- ❑ Switch Off and On the instrument.
- ❑ Be sure that the Bluetooth dongle A1436 is properly initialized. If not the Bluetooth dongle must be initialized as described in chapter 4.4.9 *Communication*.
- ❑ On PC configure a Standard Serial Port to enable communication over Bluetooth link between instrument and PC. Usually, no code for pairing the devices is needed.
- ❑ Run the *EurolinkPRO* program.
- ❑ The PC and the instrument will automatically recognize each other.
- ❑ The instrument is prepared to communicate with the PC.

How to configure a Bluetooth link between instrument and Android device

- ❑ Switch Off and On the instrument.
- ❑ Be sure that the Bluetooth dongle A 1436 is properly initialized. If not, the Bluetooth dongle must be initialized as described in chapter 4.4.9 *Communication*.
- ❑ Some Android applications automatically carry out the setup of a Bluetooth connection. It is preferred to use this option if it exists. This option is supported by Metrel's Android applications.
- ❑ If this option is not supported by the selected Android application, then configure a Bluetooth link via Android device's Bluetooth configuration tool. Usually, no code for pairing the devices is needed.
- ❑ The instrument and Android device are ready to communicate.

How to configure a Bluetooth link between EurotestPV Lite instrument and Metrel Powermeter

- ❑ Switch Off and On the EurotestPV Lite instrument.
- ❑ Be sure that the EurotestPV Lite Bluetooth dongle A 1436 is connected and properly initialized. If not the Bluetooth dongle must be initialized as described in chapter 4.4.9 *Communication*.
- ❑ Switch On the Metrel Powermeter. A second Bluetooth dongle A 1436 should be inserted to the Powermeter's PS/2 port.
- ❑ Be sure that the second Bluetooth dongle A 1436 is properly initialized (as PowerQ device). If not, the Bluetooth dongle must be initialized as described in chapter 4.4.9 *Communication*.
- ❑ The settings in instrument's Communication menu (see chapter 4.4.9 *Communication*) should be as following:
 - COM PORT: BT DONGLE
 - BLUETOOTH DEVICES: PowerQ
- ❑ The EurotestPV Lite instrument and Powermeter are ready to communicate.

Notes:

- Sometimes there will be a demand from the PC or Android device to enter the code. Enter code 'NNNN' to correctly configure the Bluetooth link.
- The name of a correctly configured Bluetooth device must consist of the instrument type plus serial number, eg. *MI 3109-12240429D*. If the Bluetooth dongle got another name, the configuration must be repeated.

7 Upgrading the instrument

The instrument can be upgraded from a PC via the RS232 communication port. This enables to keep the instrument up to date even if the standards or regulations change. The upgrade can be carried with a help of special upgrading software and the communication cable as shown on *Figure 6.14*. Please contact your dealer for more information.

8 Maintenance

Unauthorized persons are not allowed to open the EurotestPV Lite instrument. There are no user replaceable components inside the instrument, except the battery and fuses under rear cover.

8.1 Fuse replacement

There are two fuses under the back cover of the EurotestPV instrument.

- F2, F3 FF 315 mA / 1000 V d.c. , 32×6 mm (Breaking capacity: 50 kA)

Optional accessory A 1385 PV test lead has replaceable fuse in each test lead.

- FF 315 mA / 1000 V d.c. , 32×6 mm (Breaking capacity: 50 kA)

Warnings:

-  **Disconnect all measuring accessory and switch off the instrument before opening battery / fuse compartment cover, hazardous voltage inside!**
- Replace blown fuse with original type only, otherwise the instrument or accessory may be damaged and/or operator's safety impaired!

8.2 Cleaning

No special maintenance is required for the housing. To clean the surface of the instrument or accessory use a soft cloth slightly moistened with soapy water or alcohol. Then leave the instrument or accessory to dry totally before use.

Warnings:

- Do not use liquids based on petrol or hydrocarbons!
- Do not spill cleaning liquid over the instrument!

8.3 Periodic calibration

It is essential that the test instrument is regularly calibrated in order that the technical specification listed in this manual is guaranteed. We recommend an annual calibration. Only an authorized technical person can do the calibration. Please contact your dealer for further information.

8.4 Service

For repairs under warranty, or at any other time, please contact your distributor.

9 Technical specifications

9.1 Insulation resistance (of PV systems) R_{OC+} , R_{OC-} and R_{OC}

R_{OC+} , R_{OC-}

Insulation resistance (nominal voltages 50 V_{DC}, 100 V_{DC} and 250 V_{DC})

Measuring range according to EN61557 is 0.15 M Ω ÷ 199.9 M Ω .

Measuring range (M Ω)	Resolution (M Ω)	Accuracy
0.00 ÷ 19.99	0.01	±(5 % of reading + 3 digits)
20.0 ÷ 99.9	0.1	±(10 % of reading)
100.0 ÷ 199.9		±(20 % of reading)

Insulation resistance (nominal voltages 500 V_{DC} and 1000 V_{DC})

Measuring range according to EN61557 is 0.15 M Ω ÷ 1 G Ω .

Measuring range (M Ω)	Resolution (M Ω)	Accuracy
0.00 ÷ 19.99	0.01	±(5 % of reading + 3 digits)
20.0 ÷ 199.9	0.1	±(5 % of reading)
200 ÷ 999	1	±(10 % of reading)

R_{OC}

Measuring range (M Ω)	Resolution (M Ω)	Accuracy
0.00 ÷ 19.99	0.01	Calculated value $R_{OC} = \frac{U_{OC}}{U_m} \cdot \frac{R_{OC+} \cdot R_{OC-}}{R_{OC+} - R_{OC-}}$
20.0 ÷ 199.9	0.1	
200 ÷ 999	1	

Voltage

Measuring range (V)	Resolution (V)	Accuracy
0 ÷ 1200	1	±(3 % of reading + 3 digits)

Nominal voltages50 V_{DC}, 100 V_{DC}, 250 V_{DC}, 500 V_{DC}, 1000 V_{DC}

Open circuit voltage-0 % / +20 % of nominal voltage

Measuring current.....min. 1 mA at R_N=U_N×1 k Ω /V

Short circuit current..... max. 3 mA

The number of possible tests..... > 1200, with a fully charged battery

Auto discharge after test.

Specified accuracy is valid if 3-wire test lead is used while it is valid up to 100 M Ω if tip commander is used.

Specified accuracy is valid up to 100 M Ω if relative humidity > 85 %.

In case the instrument gets moistened, the results could be impaired. In such case, it is recommended to dry the instrument and accessories for at least 24 hours.

The error in operating conditions could be at most the error for reference conditions (specified in the manual for each function) ±5 % of measured value.

The insulation resistance results in Autotest may slightly differ in comparison to results in Single test mode because of the three-wire connection and the internal resistance of the measuring instrument.

9.2 Continuity

9.2.1 Resistance R LOW Ω

Measuring range according to EN61557 is 0.16 Ω ÷ 1999 Ω .

Measuring range R (Ω)	Resolution (Ω)	Accuracy
0.00 ÷ 19.99	0.01	$\pm(3\%$ of reading + 3 digits)
20.0 ÷ 199.9	0.1	$\pm(5\%$ of reading)
200 ÷ 1999	1	

Open-circuit voltage6.5 VDC ÷ 9 VDC

Measuring currentmin. 200 mA into load resistance of 2 Ω

Test lead compensationup to 5 Ω

The number of possible tests> 2000, with a fully charged battery

Automatic polarity reversal of the test voltage.

9.2.2 Resistance CONTINUITY

Measuring range (Ω)	Resolution (Ω)	Accuracy
0.0 ÷ 19.9	0.1	$\pm(5\%$ of reading + 3 digits)
20 ÷ 1999	1	

Open-circuit voltage6.5 VDC ÷ 9 VDC

Short-circuit currentmax. 8.5 mA

Test lead compensationup to 5 Ω

9.3 PV tests

9.3.1 Accuracy of STC data

Accuracy of STC values is based on accuracy of measured electrical quantities, accuracy of environmental parameters, and entered parameters of PV module. See *Appendix E: PV measurements – calculated values* for more information about calculation of STC values.

9.3.2 Panel, Inverter

DC Voltage

Measuring range (V)	Resolution (V)	Accuracy
0.0 ÷ 14.9	0.1	indicative
15.0 ÷ 199.9	0.1	± (1.5 % of reading + 5 digits)
200 ÷ 999	1	±1.5 % of reading

DC Current

Measuring range (A)	Resolution (mA)	Accuracy
0.00 ÷ 19.99	10	±(1.5 % of reading + 5 digits)
20.0 ÷ 199.9	100	±1.5 % of reading
200 ÷ 299 (999*)	1000	±1.5 % of reading

* Customized clamps

DC Power

Measuring range (W)	Resolution (W)	Accuracy
0 ÷ 1999	1	± (2.5 % of reading + 6 digits)
2.00 k ÷ 19.99 k	10	±2,5 % of reading
20.0 k ÷ 199.9 k	100	
200 k ÷ 999 k	1000	

AC Voltage

Measuring range (V)	Resolution (V)	Accuracy
0.0 ÷ 99.9	0.1	± (1.5 % of reading + 3 digits)
100.0 ÷ 199.9	0.1	±1.5 % of reading
200 ÷ 999	1	

AC Current

Measuring range (A)	Resolution (mA)	Accuracy
0.00 ÷ 9.99	10	±(1.5 % of reading + 3 digits)
10.00 ÷ 19.99	10	±1.5 % of reading
20.0 ÷ 299.9	100	

AC Power

Measuring range (W)	Resolution (W)	Accuracy
0 ÷ 1999	1	± (2.5 % of reading + 6 digits)
2.00 k ÷ 19.99 k	10	±2.5 % of reading
20.0 k ÷ 199.9 k	100	

Notes:

- Error of external voltage and current transducers is not considered in this specification.
- For measuring range, resolution and accuracy of the 3-phase a.c. powers (Pt, P1, P2 and P3) in AC3 and AC3/DC inverter sub-functions refer to technical specifications of applied Metrel Powermeter.

9.3.3 I-V curve**DC Voltage**

Measuring range (V)	Resolution (V)	Accuracy
0.0 ÷ 15.0	0.1	indicative
15.1 ÷ 199.9	0.1	± (2 % of reading + 2 digits)
200 ÷ 999	1	±2 % of reading

DC Current

Measuring range (A)	Resolution (A)	Accuracy
0.00 ÷ 9.99	0.01	±(2 % of reading + 3 digits)
10.00 ÷ 15.00	0.01	±2 % of reading

DC Power

Measuring range (W)	Resolution (W)	Accuracy
0 – 1999	1	± (3 % of reading + 5 digits)
2.00 k ÷ 14.99 k	10	± 3 % of reading

Maximal power of PV string: 15 kW

9.3.4 Uoc - Isc**DC Voltage**

Measuring range (V)	Resolution (V)	Accuracy
0.0 ÷ 15.0	0.1	indicative
15.1 ÷ 199.9	0.1	± (2 % of reading + 2 digits)
200 ÷ 999	1	±2 % of reading

DC Current

Measuring range (A)	Resolution (A)	Accuracy
0.00 ÷ 9.99	0.01	±(2 % of reading + 3 digits)
10.00 ÷ 15.00	0.01	±2 % of reading

Maximal power of PV string: 15 kW

9.3.5 Environmental parameters

Solar Irradiance

Probe A 1399

Measuring range (W/m ²)	Resolution (W/m ²)	Accuracy
300 ÷ 999	1	± (5 % of reading + 5 digits)
1000 ÷ 1999	1	± 5 % of reading

Measuring principle: Pyranometer

Operation conditions:

Working temperature range -40 °C ÷ 55 °C

Designed for continuous outdoor use.

Probe A1427

Measuring range	Resolution (W/m ²)	Accuracy
300 ÷ 999 W/m ²	1	± (4 % + 5 digits)
1.00 ÷ 1.75 kW/m ²	10	± 4 %

Measuring principle: Monocrystall PV cell, temperature compensated

Operation conditions:

Working temperature range -20 °C ÷ 55 °C

Protection degree IP 44

Temperature (cell and ambient)

Probe A 1400

Measuring range (°C)	Resolution (°C)	Accuracy
-10.0 ÷ 85.0	0.1	± 5 digits

Designed for continuous outdoor use.

Note:

- Given accuracy is valid for stable irradiance and temperature during the test.

9.4 Autotest

Consider specifications of individual measurements.

See chapters:

9.1 Insulation resistance (of PV systems) ROC+, ROC- and ROC and

9.3 PV tests

9.5 General data

Power supply voltage.....	9 V _{DC} (6×1.5 V battery or accu, size AA)
Operation.....	typical 20 h
Charger socket input voltage	12 V ± 10 %
Charger socket input current	400 mA max.
Battery charging current	250 mA (internally regulated)
Measuring category	1000 V DC CAT II 600 V CAT III 300 V CAT IV
Protection classification	double insulation
Pollution degree.....	2
Protection degree	IP 40
Altitude.....	≤ 2000 m
Display	128x64 dots matrix display with backlight
Dimensions (w × h × d).....	23 cm × 10.3 cm × 11.5 cm
Weight	1.3 kg, without battery cells
Reference conditions	
Reference temperature range.....	10 °C ÷ 30 °C
Reference humidity range.....	40 %RH ÷ 70 %RH
Operation conditions	
Working temperature range	0 °C ÷ 40 °C
Maximum relative humidity	95 %RH (0 °C ÷ 40 °C), non-condensing
Operation.....	Outdoor use
Storage conditions	
Temperature range.....	-10 °C ÷ +70 °C
Maximum relative humidity	90 %RH (-10 °C ÷ +40 °C) 80 %RH (40 °C ÷ 60 °C)
Communication transfer speed:	
RS 232	57600 baud
RS 232 wireless.....	9600 baud
USB	256000 baud
Size of memory:	
I-V curve:	ca. 500 measurements
Other measurements:	ca 1800 measurements
EMC	
Emission	Class B
Immunity.....	Basic electromagnetic environment (Portable test and measurement equipment)

The error in operating conditions could be at most the error for reference conditions (specified in the manual for each function) +1 % of measured value + 1 digit, unless otherwise specified in the manual for particular function.

Appendix B - Accessories for specific measurements

The table below presents recommended standard and optional accessories required for specific measurement. Please see attached list of standard accessories for your set or contact your distributor for further information.

Function	Suitable accessories (Optional with ordering code A....)
Insulation resistance	<ul style="list-style-type: none"> <input type="checkbox"/> Universal PV test lead, 3 x 1.5 m <input type="checkbox"/> PV Safety probe (A 1384)
R LOW Ω resistance Continuity	<ul style="list-style-type: none"> <input type="checkbox"/> PV continuity test lead, 2 x 1.5 m
Panel Isc / Uoc I/V curve	<ul style="list-style-type: none"> <input type="checkbox"/> Universal PV test lead, 3 x 1.5 m <input type="checkbox"/> PV Safety probe (A 1384) <input type="checkbox"/> PV MC 4 adapters <input type="checkbox"/> PV MC3 adapters <input type="checkbox"/> AC/ DC current clamp (A 1391) <input type="checkbox"/> PV Remote unit (A 1378)
Inverter	<ul style="list-style-type: none"> <input type="checkbox"/> Universal PV test lead, 3 x 1.5 m <input type="checkbox"/> PV Safety probe (A 1384) <input type="checkbox"/> PV MC 4 adapters <input type="checkbox"/> PV MC3 adapters <input type="checkbox"/> PV Remote unit (A 1378) <input type="checkbox"/> PV fused test lead (A 1385) <input type="checkbox"/> AC/DC current clamp (A 1391) <input type="checkbox"/> AC current clamp (A 1018) <input type="checkbox"/> AC current clamp (A 1019)
Environment	<ul style="list-style-type: none"> <input type="checkbox"/> Temperature probe (A 1400) <input type="checkbox"/> Pyranometer (A 1399) <input type="checkbox"/> Monocrystal PV cell (A 1427) <input type="checkbox"/> PV Remote unit (A 1378)
Auto	<ul style="list-style-type: none"> <input type="checkbox"/> Universal PV test lead, 3 x 1.5 m <input type="checkbox"/> PV MC 4 adapters <input type="checkbox"/> PV MC3 adapters

Appendix E – PV measurements - calculated values

Calculation with known U, I (DC, AC), configuration of modules into a string (M - modules in serial, N - modules in parallel), environment parameters (Irr, T) and data supplied by the panels manufacturer (U, I (AC, DC), phase, I_{stc}, α, β, γ, P_{nom}, NOCT, Irr, Irr_{stc}, Tamb or Tcell)

Panel (DC):

$$P_{WP} = U_{WP} * I_{WP} = U_{meas} * I_{meas}$$

Where

$$P_{WP} = P_{DC} \quad \text{for INVERTER measurements}$$

$$P_{WP} = P_{meas} \quad \text{for PANEL measurements}$$

WP stands for DC Working Point of the inverter – should be actual MPP of the connected PV string but not necessary.

Inverter (AC):

$$P_{AC} = \sum_{i=1}^3 U_{meas,i} I_{meas,i} \cos \varphi_i$$

U, I and phase are measured on inverter connectors, i is for multi-phase systems (i = 1 ÷ 3).

Conversion efficiency:

1. panel:

$$\eta_1 = \frac{P_{WP_STC}}{P_{nom}}$$

Where

$$P_{WP_STC} = P_{stc} \quad \text{measured output power of the panel at STC and}$$

$$P_{nom} = P_{max} \quad \text{nominal output power of the panel at STC}$$

$$\eta_2 = \frac{P_{WP}}{P_{theo}}, \quad P_{theo} = M * N * P_{nom} * \frac{Irr}{Irr_{STC}},$$

where P_{nom} is nominal power of panel at STC, Irr_{STC} is nominal irradiance at STC ($Irr_{STC} = 1000 \text{ W/m}^2$), Irr is measured irradiance, M is number of modules in serial and N is number of modules in parallel.

η_2	Efficiency of panel (simplified)
----------	----------------------------------

Ptheo	Theoretical power of string at measured irradiance
Pnom	nominal power of panel at STC
Irr_{stc}	nominal irradiance at STC (Irr_{stc} = 1000 W/m²)
Irr	measured irradiance
M	number of modules in serial
N	number of modules in parallel

Depending on temperature criterion for PASS is:

- If $T_{amb} < 25\text{ °C}$ or $T_{cell} < 40\text{ °C} \Rightarrow \eta_2 > 0.85$
- If $T_{amb} > 25\text{ °C}$ or $T_{cell} > 40\text{ °C} \Rightarrow \eta_2 > (1 - \eta_{PV} - 0.08)$,

where η_{PV} is calculated depending on type of temperature being measured as

$$\eta_{PV} = \left[T_{amb} - 25 + (NOCT - 20) \frac{Irr}{0,08} \right] \cdot \gamma$$

or

$$\eta_{PV} = (T_{cell} - 25) \cdot \gamma$$

where NOCT is nominal operating temperature of the cell (data supplied by the panels manufacturer) and γ is coeff. of temperature of power characteristic of PV module (inserted value from 0,01 to 0,99) (data supplied by the panels manufacturer).

NOCT	nominal operating temperature of the cell (data supplied by the panels manufacturer)
γ	coeff. of temperature of power characteristic of PV module (inserted value from 0,01 to 0,99) (data supplied by the panels manufacturer)

2. inverter:

$$\eta = \frac{P_{AC}}{P_{DC}}$$

Calculation of conversion efficiency with comparison of STC and measured-corrected values

(U, I (AC, DC), phase, Irr_{stc}, T_{stc}, P_{nom}, Irr, T_{cell}, R_s, α , β , I_{sc}, M, N)

Panel:

Measured U and I are corrected to STC conditions:

$$I_{STC} = I_{meas} \cdot (1 + \alpha_{rel} \cdot (T_{STC} - T_{meas})) \cdot \left(\frac{Irr_{STC}}{Irr_{meas}}\right)$$

$$U_{STC} = U_{meas} + U_{OC_meas} \cdot (\beta_{rel} \cdot (T_{STC} - T_{meas}) + \alpha \cdot \ln\left(\frac{Irr_{STC}}{Irr_{meas}}\right)) - R_s \cdot (I_{STC} - I_{meas})$$

$$R_s = \frac{M}{N} \cdot R_{s_nom}$$

where I_{meas} and U_{meas} are measured direct current and voltage at panel, Irr_{STC} is irradiance at STC, Irr is measured irradiance, α is irradiance correction factor, α_{rel} and β_{rel} are the current and voltage temperature coeff. off panel, T_{STC} is temperature at STC, T_{meas} is measured temperature, R_s is serial resistance of panel / string, M is number of modules in serial and N is number of modules in parallel.

I_{stc}, U_{stc}	Calculated values of current and voltage at standard test condition
I_{meas}, U_{meas}	measured direct current and voltage at panel
Irr_{stc}	irradiance at STC
Irr	measured irradiance
α	irradiance correction factor (typical 0,06)
α_{rel}, β_{rel}	current and voltage temperature coeff. of panel
T_{stc}	temperature at STC
T_{meas}	measured temperature
R_{snom}	serial resistance of module
R_s	serial resistance of string
M	number of modules in serial
N	number of modules in parallel

$$P_{STC} = I_{STC} \cdot U_{STC}$$

Conversion efficiency:

1. inverter:

$$\eta = \frac{P_{AC}}{P_{DC}}$$

Insulation measurements of PV modules and strings

The first insulation method described in the standard IEC 62446 results in two values:

- R_{OC+} insulation resistance between positive output and earth
- R_{OC-} insulation resistance between negative output and earth

The second method described in the standard returns only one value:

- R_{SC} insulation resistance between short circuit outputs and earth

To get comparable results both values of the first method must be converted to a single value result. This can be done using the bellow equation, which is based on the electrical substitute model of PV modules and returns the same or close value to the insulation resistance measured by the second method.

$$R_{OC} = \frac{U_{OC}}{U_m} * \frac{R_{OC+} * R_{OC-}}{R_{OC+} - R_{OC-}} = R_{SC}$$

To get accurate results care must be taken, when performing insulation measurements. PV module or string can have a significant capacitive nature therefore the duration of the measurement must be long enough, that the result is stable. Therefore, the user has to set up the duration of the measurement, which can be up to one minute. If the measurement time is too short and the displayed value is not stable the final result must be treated only as informational.