



MI 3144
Euro Z 800 V

MI 3143
Euro Z 440 V

Measuring
instruments
and testers

Most powerful Industrial Safety & Quality bundles

MI 3144 Euro Z 800 V and MI 3143 Euro Z 440 V

MI 3144 Euro Z 800 V or MI 3143 Euro Z 440 V both are fully operated test instruments that could be driven through Android Application aMESM or one of supported instrument like MI 3155 EurotestXD or MI 3325 MultiservicerXD. Powerful features for industrial environment are implemented where hi test current is crucial demand to evaluate results.

MAIN FEATURES

- High Precision 4-wire 300A Z Line and Z Loop Impedance Tester
- High Range 800 V / 16 ... 420 Hz AC Networks
- High Range 440 V / 16 ... 420 Hz AC Networks
- DC Source & Line Resistance 3 ... 260 V DC
- High Current dR 300A 4-wire Partial Voltage drops
- High Current dR 300A 4-wire Current's Path Resistances
- Earth Leakage Relay (ELR) Trip-out Testing Time and Current
- ELR current injection test;
- ELR supported types AC, A, B;
- Ground Fault Analysis with Contact, Touch and Step Voltage
- Floating Voltmeter for partial contact results
- One-Clamp High Current Ground Integrity method with clamps (Flex & Iron)

MI 3144 MI 3143

-
-
-
-
-
-
-
-
-
-
-
-



Eurotest XD/XC, Multiservicer XD or Android App

APPLICATIONS

- Live Power Transformer High Precision 4-wire 300 A Z Line / Loop Impedance Testing
- Partial Voltage Drops and Partial Clamp Current's Path* Resistances
- Airports High Frequency Band 16 ... 420 Hz Installation Impedances testing
- DC Networks' and Power Sources' Line and Loop Resistances
- Flex & Iron One-Clamp High Current dR 300 A Grounding method for Lightning systems
- High Current dR 300 A Integrity of Grounding system with Flex and Iron One-Clamp method
- ELR (MRCD) trip-out Current and trip-out Time testing
- Earth Potentials by method of measuring Step, Touch and Transfer voltages

GENERAL DATA

- CAT IV 600 V (3000 m) safety category;
- Portable battery (Li-ion) or mains powered test instrument;
- IP protection: IP65 (case closed), IP54 (case opened);
- Improved thermal performance;
- Bluetooth communication;
- Black box design (Can be remote-controlled via an Android device).

STANDARDS

Electromagnetic compatibility:

- EN 61326

Safety:

- EN 61010 - 1
- EN 61010 - 2 - 030
- EN 61010 - 031

Functionality:

- EN 61557
- IEEE 81 - 2012
- IEC 60947 - 2 Annex M
- IEC 60609 - 0

Li-ion battery pack:

- EN 62133 - 2



Most powerful Industrial Safety & Quality bundle

MI 3144 Euro Z 800 V and MI 3143 Euro Z 440 V



Automatic trip out protection ability test in case of faults in transformers, generators, turbines, contactors, distribution boards and switchyards whenever energetic loads and sources of protection exceed 200A need precise, robust and accurate measuring method to evaluate results for first inspection and periodical predictive maintenance or fast troubleshooting on any industrial platform.

High precision line and loop impedances on AC and DC circuits is on the top of the importance list for high test current, 4-wire connectivity, temperature management with selectable test loads, calculations and algorithms that offer robustness and stable high-resolution results.

High Current dR 300A loop and line measurements with completely insulated voltmeter with supported current clamps enable testing of partial currents and partial voltage drops. This innovation made several applications possible, from measuring partial resistance of separate contacts to controlled fault with high current injecting method to partial ground paths. No more cable screens removal for accurate evaluation.

Contact voltages can be measured during generated fault to ground. With insulated voltmeter and parallel 1 kOhm resistor connected as body resistance simulator, realistic touch and step voltages can be

scaled to faults like phase to ground or even a lightning strike.

ELR feature supports AC, A and B types of electrical leakage relay testing with fault current injection and trip-out time measurement. Testing relays to proper reaction in case of faults or leakages, high neutral current, missing phase situations or asymmetry will protect people and livestock as well as electrical loads and sources.

DC Sources, accumulators and batteries, DC lines and circuits, fuses, switches and contacts can be evaluated on live circuits in range from 3 V DC up to 260 V DC. Quality of the batteries can be estimated by voltage drop reading and evaluated as drop in quality through years of usage.

MI 3144 Euro Z 800 V and MI 3143 Euro Z 440 V are multi-function, battery (Li-ion) or mains powered test instrument with excellent IP protection: IP65 (case closed), IP54 (case opened).

Professional kelvin crocodiles and full set of accessories complete the package prepared for field testing. Several types of current clamps including long flex clamp make industrial testing possible.

Bundle set could be packed into professional high IP protected portable case on wheels. Several solutions are prepared; from easy field transportation to simple ready to test procedure.

FIELD TEST EVALUATION

After months of evaluation on real field industrial applications we are capable to make some real conclusions. The bundle in the portable case with MI 3144 Euro Z 800 and MI3155 Eurotest XD is the most remarkable powerful industrial safety and quality test set package. Recommended with no hesitation.



Make your competency highly professional.

MEASUREMENT FUNCTIONS

		MI 3144	MI 3143	Instrument
High Current Impedance 4-wire	Zline Zloop Impedance	•	•	Supported by following testers and applications over bluetooth or cable communication: • MI 3155 EurotestXD • MI 3152 EurotestXC • MI 3152HEurotestXC 2.5 KV • MI 3325 MultiserviserXD • aMESM Android APP
	ΔR High Current	•	•	
	R Selective	•		
DC Source & Line Resistance	DC Source	•		
	DC Line Resistance	•		
Earth Potential [U]	Utouch	•	•	
	Ustep	•	•	
	Ucontact	•	•	
ELR Test [I and t]	Residual operating current	•		
	Combination time	•		
Current [I]	A 1609 flex clamp	•		
	A 1227 flex clamp	Optional		
	A 1281 iron clamp	Optional		

Most powerful Industrial Safety & Quality bundle

Technical specifications

MI 3144 and MI 3143*

High Current Impedance [Z], ΔR, R Selective

Z line mΩ, Z loop mΩ

Measuring range according to EN61557-3: 12.0 mΩ ... 19.99 Ω

Measurement principle Voltage / Current measurement (synchronous sampling)

Loop/Line Impedance	Measuring range	Resolution	Uncertainty (* See note)
Zline Zloop Impedance	0,1 mΩ ... 199,9 mΩ	0,1 mΩ	±(5 % of reading + 3 mΩ)
ΔR High Current	200 mΩ ... 1999 mΩ	1 mΩ	
R Selective (only MI 3144)	2,00 Ω ... 19,99 Ω	10 mΩ	±(5 % of reading + 3digits)

16 Hz → Nominal frequency → 400 Hz

40 Vac → Nominal voltage range → 800 Vac
470 Vac*

Test load parameter 16.6 %, 33.3%, 50 %, 66.6%, 83.3%, 100%

Test method 4-wire / I_{psc} - I_{max} , I_{min} , I_{max2p} , I_{min2p} , I_{max3p} , I_{min3p} / R and X_L values / Averaging option / Automatic range selection

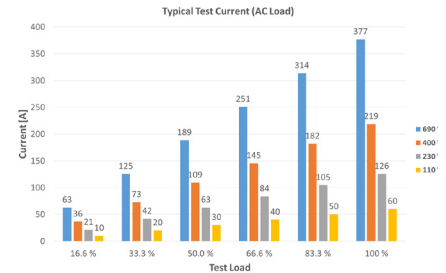

MI 3144

DC Sources & Line Resistance [R]

R line mΩ

Measurement principle: Voltage (dc) / Current (dc) measurement

Resistance	Measuring range	Resolution	Uncertainty
R	0 mΩ ... 1999 mΩ	1 mΩ	±(5 % of reading + 3 digits)
	2,00 Ω ... 19,99 Ω	10 mΩ	

3 Vdc → Nominal voltage range → 260 Vdc

Max test current (I_{test}) ~10 A / Duration 20 ms / 4-wire / Automatic range

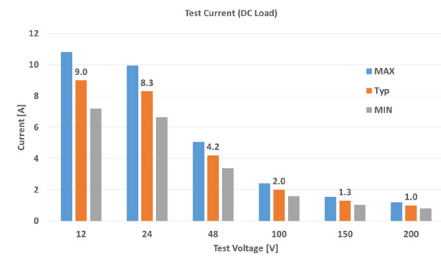

MI 3144 and MI 3143*

Earth Potential [U]

U_{touch} , U_{step} , $U_{contact}$

Voltage	Measuring range	Resolution	Uncertainty (* See note)
U_{touch}	0,0 V ... 199,9 V	0,1 V	calculated value
	200 V ... 999 V	1 V	

Sub-result in measurement function U_{touch}

Voltage	Measuring range	Resolution	Uncertainty (* See note)
U_m	1 mV ... 1999 mV	1 mV	±(2 % of reading + 2 digits)
	2,00 V ... 19,99 V	10 mV	
	20,0 V ... 199,9 V	0,1 V	

16 Hz → Nominal frequency → 400 Hz

40 Vac → Nominal voltage range → 800 Vac
470 Vac*

$U_{touch} = U_m \times (I_{fault}/I_{test})$ I_{fault} range (selectable) 10 A ... 200 kA

A 1597 Human body probe with an internal resistance of 1 kΩ ±1 %.

Most powerful Industrial Safety & Quality bundle

Technical specifications

MI 3144

ELR Test [I and t]

ELR Current Injection Test and ELR Combination Time Test

Residual operating current	Measuring range	Resolution	Uncertainty (* See note)
I	0,1 mA ... 199,9 mA	0,1 mA	±(5 % of reading + 3 digits)
	200 mA ... 1999 mA	1 mA	
	2,00 A ... 19,99 A	10 mA	
Combination time	Measuring range	Resolution	Uncertainty
t	0,1 ms ... 199,9 ms	0,1 ms	±(2 % of reading + 3 digits)
	200 ms ... 1999 ms	1 ms	
	2,00 s ... 19,99 s	10 ms	

Nominal voltage range (P1 - P2) 40 ... 800 V



Nominal frequency range (P1 - P2) 16,7 ... 400 Hz

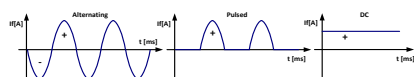
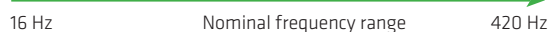

Current Waveform

Alternating, Pulsating, DC

Test current selectable 3 mA, 5 mA, 6 mA, 10 mA, 15 mA, 30 mA, 50 mA, 0,1 A, 0,15 A, 0,25 A, 0,3 A, 0,5 A

Number of turns - up to 10

MI 3144

Current [I]

Iron current clamps A 1281 and Flex current clamp A 1227 and A 1609

Current	Type	Range	Measuring range	Display range	Resolution	Overall Uncertainty (* See note)
I	A 1281	0,5 A	10 mA ... 749 mA	0 ... 749 mA	1 mA	±0,5 % * Irms
		5 A	0,1 A ... 7,49 A	0,00 ... 7,49 A	0,01 A	
		100 A	2 A ... 149 A	0,0 ... 99,9 A	0,1 A	
		1000 A	20 A ... 999 A	100 ... 149 A	1 A	
				0 ... 999 A	1 A	
	A 1227	30 A	0,6 A ... 59,9 A	0,0 ... 59,9 A	0,1 A	±1,5 % * Irms
	A 1609	300 A	6 A ... 599 A	0 ... 599 A	1 A	
		3 kA	0,06 kA ... 5,99 kA	0,00 ... 5,99 kA	0,01 kA	

* only MI 3144 Euro Z 800 V

GENERAL DATA

Battery power supply	7,2 V DC (4,4 Ah Li-ion)
Battery charging time	typical 3,0 h (deep discharge)
Mains power supply	90 ... 260 V AC, 45 ... 65 Hz, 80 VA
Over-voltage category	300 V CAT II
Battery operation time:	
Idle state	> 24 h
Measurements	> 12 h continuous testing for line, loop, high current
Auto - off timer	10 min (idle state)
Protection classification	reinforced insulation <input type="checkbox"/>
Measuring category	600 V CAT IV
Pollution degree	2
Degree of protection	IP 65 (case closed), IP 54 (case open)
Dimensions (w x h x d)	36 cm x 16 cm x 33 cm
Weight	7 kg, (without accessories)
Sound / Visual warnings	yes
Reference conditions:	
Reference temperature range	25 °C ± 5 °C
Reference humidity range	40 % RH ... 60 % RH

Operation conditions:

Working temperature range	-10 °C ... 50 °C
Maximum relative humidity	90 % RH (0 °C ... 40 °C), non-condensing
Working nominal altitude	up to 3000 m

Storage conditions:

Temperature range	-10 °C ... 70 °C
Maximum relative humidity	90 %RH (-10 °C ... 40 °C) 80 %RH (40 °C ... 60 °C)

RS 232 communication:

RS 232 serial communication	galvanic separated
Baud rate	115200 baud rate, 1 stop bit, no parity
Connector	standard RS232 9-pin D female

Bluetooth communication:

Device pairing code	1234
Baud rate	115200 bit/s
Bluetooth module	class 2

Most powerful Industrial Safety & Quality bundle

Standard set MI 3144 / MI 3143

ORDERING INFORMATION (MI 3144)



Standard set (MI 3144)

- Instrument MI 3144 Euro Z 800 V
- Mains cable
- RS232-PS/2 cable
- Test lead 5 m, black, 2 pcs
- Test lead 5 m, red, 2.5 mm², 2 pcs
- Test lead 50 m, red, 2.5 mm²*
- Test lead 20 m, black
- Test lead 50 m, green*
- Large Kelvin test clip, 2 pcs
- Crocodile clip, black, 2 pcs
- Crocodile clip, red, 2 pcs
- Crocodile clip, green
- Test probe, black, 2 pcs
- Test probe, red, 2 pcs
- G clamp
- Human body resistance probe
- Test rod, 2 pcs
- Step voltage plates, 2 pcs
- Metrel ES Manager BASIC license**
- Metrel aMESM Android app with P 1102 PRO license key
- Short instruction manual
- Calibration certificate
- Protective bag for accessories
- Soft carrying bag*

* Replaced by test leads on a cable reel in MI 3144 EU set.



Euro set MI 3144 (EU)

- MI 3144 ST
- Test lead 5 m, green
- Test lead on a cable reel, 75 m, red, 2.5 mm²
- Test lead on a cable reel, 75 m, green
- Professional current earth spike, 42 cm
- 1-phase flexible current clamp 3000 / 300 / 30 A / 1 V (A 1609) with 5m current clamp extension cable (A 1648)
- Current clamp A 1281 extension cable, 5 m
- Metrel ES Manager PRO license**
- Jumbo case
- Extension cable reel
- Jumbo case mount

** Metrel ES Manager can be downloaded free of charge from Metrel Web server.

ORDERING INFORMATION (MI 3143)



Standard set (MI 3143)

- Instrument MI 3143 Euro Z 440 V
- Mains cable
- RS232-PS/2 cable
- Test lead, 2-wire, 2 pcs*
- Crocodile clip, black, 2 pcs
- Crocodile clip, red, 2 pcs
- Test probe, black, 2 pcs
- Test probe, red, 2 pcs
- Metrel ES Manager BASIC license**
- Metrel aMESM Android app with P 1102 PRO license key
- Short instruction manual
- Calibration certificate
- Protective bag for accessories

* Replaced by 5 m and 20 m test leads in MI 3143 EU set.



Euro set MI 3143 (EU)

- MI 3143 ST
- Test lead 5 m, black, 2 pcs
- Test lead 5 m, red, 2.5mm², 2 pcs
- Test lead 20 m, red, 2.5mm²
- Test lead 20 m, black
- Test lead 20 m, green
- Large Kelvin test clip, 2 pcs
- G clamp
- Human body resistance probe
- Test rod, 2 pcs
- Step voltage plates, 2 pcs
- Metrel ES Manager PRO license**
- Soft carrying bag

** Metrel ES Manager can be downloaded free of charge from Metrel Web server.





























A 1658 JUMBO CASE



Most powerful Industrial Safety & Quality bundle

Optional accessories

OPTIONAL ACCESSORIES

Photo	Part No.	Description	MI 3144	MI 3143	Photo	Part No.	Description	MI 3144	MI 3143	Photo	Part No.	Description	MI 3144	MI 3143
	A 1620	Test lead 5 m, black	•	•		A 1661	Jumbo case mount for A 1660	•	•		A 1022	Test rod, 2 pcs	•	•
	A 1621	Test lead 20 m, black	•	•		A 1593	Large Kelvin test clip, 2 pcs	•	•		A 1528	Professional current earth spike, 50 cm	•	•
	A 1527	Test lead 5 m, red, 1.5 mm²	•	•		A 1595	Large test crocodile, black	•	•		S 2053	Step voltage plates, 2 pcs	•	•
	A 1640	Test lead 20 m, red, 1.5 mm²	•	•		A 1596	Large test crocodile, red	•	•		A 1609	1-phase flexible current clamp	•	
	A 1608	Test lead 20 m, green	•	•		A 1013	Crocodile clip, black, 2 pcs	•	•		A 1227	1-phase flexible current clamp 3000/300/30 A / 1 V	•	
	A 1654	Test lead on a cable reel, 50 m, red, 2.5 mm², extendable	•	•		A 1064	Crocodile clip, red, 2 pcs	•	•		A 1281	Current clamp 0,5/5/100/1000 A / 1 V	•	
	A 1509	Test lead on a cable reel, 50 m, black, extendable	•	•		A 1014	Test probe, black, 2 pcs	•	•		A 1648	Current clamp A 1281 extension cable, 5 m	•	
	A 1510	Test lead on a cable reel, 50 m, green, extendable	•	•		A 1016	Test probe, red, 2 pcs	•	•		A 1658	Jumbo case for MI 3144	•	•
	A 1619	Test lead, 2-wire, 2 pcs	•	•		A 1530	G clamp	•	•		P 1101	BASIC to PRO license key upgrade for Metrel ES Manager	•	•
	A 1660	Extension test leads on reel, 75 m, red, green, 2.5 mm²	•	•		A 1597	Human body resistance probe	•	•					

RECOMMENDED ACCESSORIES



A 1660 Extension test leads on reel, 75 m, red, green, 2.5 mm²



A 1661 Jumbo case mount for A 1660



A 1597 Human body resistance probe

Application Note - 1 (MI 3144 and MI 3143)

Live Power Transformer High Precision 4-wire 300A Z Line / Loop Impedance Testing

Power Electrical Installation's Automatic trip-out ability is the majority evaluation during maintenance process to protect power transformer in case of overloading, overheating and shorting. Heavy Industrial solution supports live testing without disconnection of the transformer from power network.



Periodical inspections of Z line and Z loop impedances can show bad contacts on busbars, condition of power switches, contactors or fuse holders. However, it needs to be working in high resolution milli-Ohm range. The accuracy of the result depends on 4-wire connection and high enough test current.

The switchyards with fuses over 100A need at least 10A test current, the more the better. Insufficient test current results in an instability of calculated short circuit current. MI 3144 impedance testing with 300 A can offer robust repeatable results with high noise immunity and reliability.

Results of L to N or L to L need to be compared between phases at the source and at the load. There should be only the calculated differences based on length and cross section of the conductors.

Performing measurements close to the power transformer's inductive impedance has a significant influence. Resistance, inductance and voltage drops need to be evaluated accordingly.

Short-circuit currents in three-phase a.c. systems calculation according to international standard IEC 60909-0

Calculated HOT Factor with the measured of $I_{psc\ min}$ and $I_{pfc\ min}$ represents unique solution for predicting the factor of reserve in case of an error on overheated transformers.

Systems with neutral conductor L-N:

$$Z_{(L-N)\ HOT} = \sqrt{(1.5 \times R_{L-N})^2 + X_{L-N}^2}$$

$$I_{KMIN\ (L-N)} = \frac{C_{MIN} \times U_{N(L-N)}}{Z_{(L-N)\ HOT}}$$

Systems without neutral conductor L-L:

$$Z_{(L-L)\ HOT} = \sqrt{(1.5 \times R_{L-L})^2 + X_{L-L}^2}$$

$$I_{KMIN\ 3ph} = \frac{C_{MIN} \times U_{N(L-L)}}{\sqrt{3}} \times \frac{2}{Z_{(L-L)\ HOT}}$$

$$I_{KMIN\ 2ph} = \frac{C_{MIN} \times U_{N(L-L)}}{Z_{(L-L)\ HOT}}$$

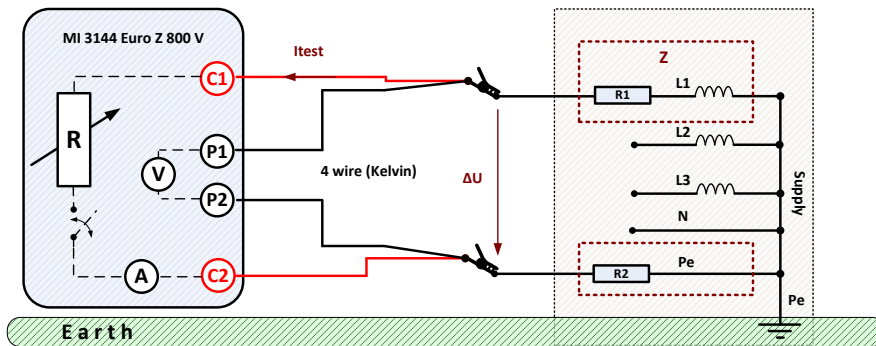

Fault Loop Impedance live testing with test current of 300 A in CAT IV environment with voltages up to 440 V (MI 3143) / 800 V (MI 3144) and frequencies in range 16 ... 420 Hz.



Four-wire type of connection with Kelvin crocodiles for high precision and stable results eliminates problems of bad connectivity and test leads compensation.



Automatic trip out ability evaluation with high accuracy and stability of result even on powerful systems with fuses above 1000 A where classic methods became useless.



Impedance with Resolution of 1mOhm detailed evaluation of transformer's $I_{sc\ min}$, $I_{sc\ max}$ and Z HOT based on overheating reserve.

Application Note - 2 (MI 3144 and MI 3143*)

Partial Voltage Drops and Partial Clamp Current's Path* Resistances

Industrial electrical installation components, fuse holders, cables, contacts, busbars and powerful switches are crucial for operability, automatic trip-out ability, and functional safety. Industrial solution supports live testing without power network disconnection.

The maintenance procedure project can be designed in advance and all replacements and repairs can become predictable.



Periodical inspections of Z line and Z loop impedances can show bad contacts on busbars, condition of power switches, contactors or fuse holders. However, it needs to be working in high resolution milli-Ohm range. The accuracy of the result depends on 4-wire connection and high enough test current.

MI 3144 impedance testing with 300 A can offer robust repeatable results with high noise immunity and reliability. Floating synchronized voltmeter can be connected parallel to any contact in the tested circuit. Series resistances do not influence the tested result.

External iron or flex clamps will give exact value of testing current through the connected path of measured contact. Circuits, connected in parallel, fuses, switches and powerful loads do not influence the tested result.

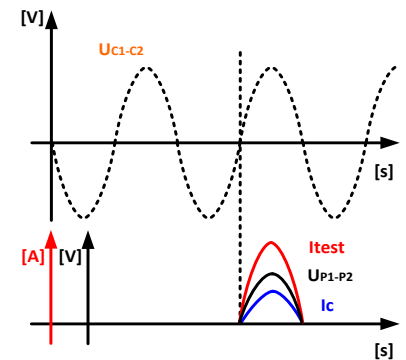
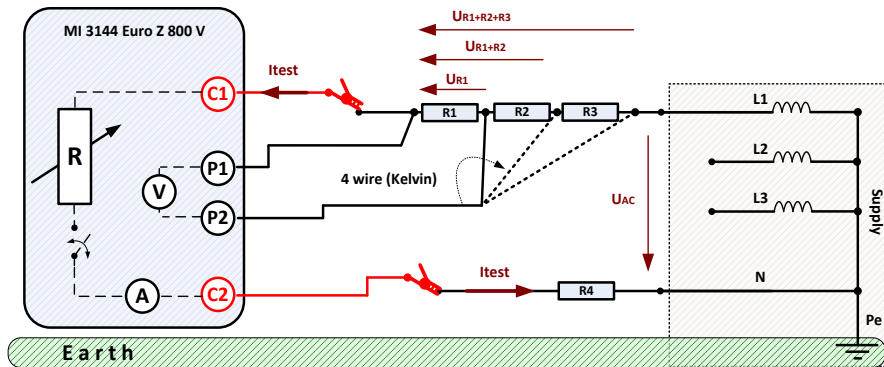

Four-wire type of connection with separated test crocodiles to eliminate serial resistances and bad connections. Test leads compensation is not needed.



Iron Clamps connected to an external output to eliminate parallel resistances and current paths where several circuits are connected to live network.



Flex Clamps connected to an external output for use on high current busbars and powerful conductors with large cross-section.

Application Note - 3 (MI 3144)

Airports High Frequency Band 16 ... 420 Hz Installation Impedances testing

Mobile Ground Power Supply or Central Supply Systems with generators, motors, converters, connection systems, sub-distribution units, cables, connectors and plugs need robust and reliable predictive maintenance. The rationality behind this is to provide safety and quality of electrical power supply and connected electrical circuits and subsystems for the aircraft in the flight preparation phase.



Using our solution in parallel to existing test procedures with load banks allows us to provide comprehensive evaluation of potential faults and errors on live electrical circuits supplied by various sources ranging from 28 V DC to 420 Hz 800 V AC. The quality of the motor, generator or transformer windings can be evaluated with the four wire method, enabling accurate evaluation on power sources as powerful as 500 kVA.

The results measured first at the source and later at the sub distribution boards are compared to find potential faults and errors. The (instrument's) resolution in the range of milliohms is sufficient to show deviations in case of bad joints on cables or bus bars, failures inside contactors or switches and within fuse holders and similar.

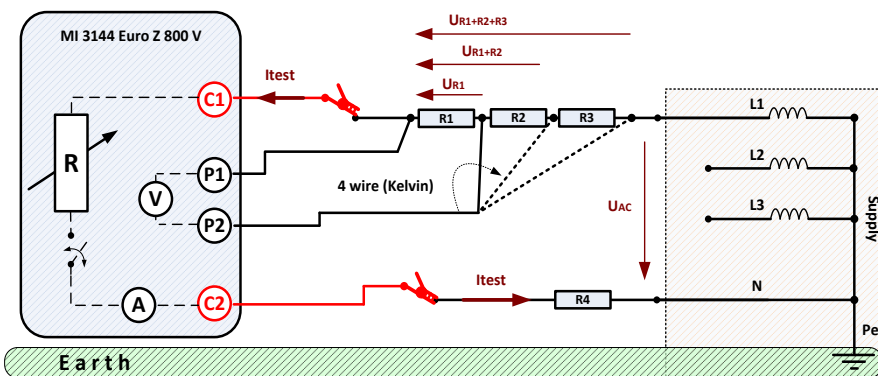

Live testing of loop Impedance of a 400 Hz AC 110 V Ground Power Supply Unit. High Power Load is connected to the GPU circuit during testing period. The measured voltage drop and loading current will give the result of possible bad contacts and short circuit current calculation to evaluate appropriate fuse protection.



GPU quality and safety can be completely evaluated with the use of MI 3155 EurotestXD in cases where IT protection circuits and insulation should be evaluated.



The comparison of results at the source with the results at sub distribution board shows potential faults and errors within the system. Testing must be predicted periodically.



Loading live circuits on a 90 kVA generator and testing with the 4-wire Kelvin method will bring stable results of 50 mΩ and 2.2 kA prospective short circuit ability same to all three phases in case of error free GPU.

The MI 3144 Euro Z 800 V portable test unit is capable of loading and testing live circuit impedance without disconnection from the power source. Memorization and periodic comparison of test results can predict the maintenance procedure, servicing and fast troubleshooting in case of malfunction.

Portability of the test system with good protection for all weather situation.

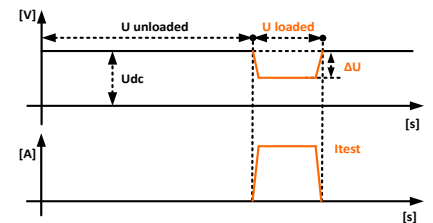
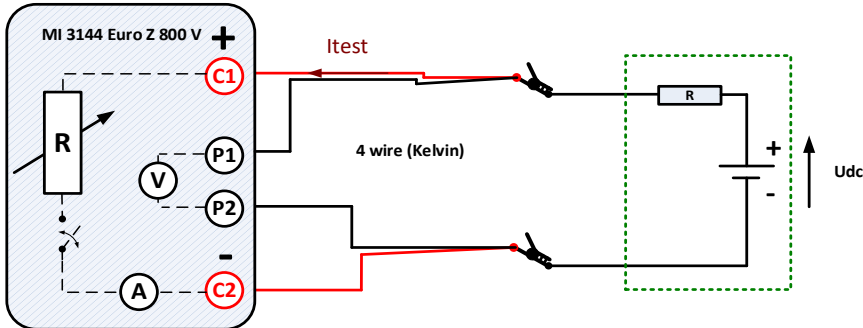

Live testing of loop resistance of DC 28 V Ground Power Supply Unit. High Power Load is connected to the GPU circuit during testing period. The measured voltage drop and loading current will give the result of possible bad contacts and short circuit current calculation to evaluate appropriate fuse protection.



Centralised rotary generators and converters need to be monitored, measured and evaluated for quality and safety in reasonable time periods.

Loading live circuits on a 28 V DC generator and testing with 4-wire Kelvin method will bring stable result of 50 mΩ on a good system between DC+ to DC- plug.

Fast and efficient transport to the field.

Application Note - 4 (MI 3144)

DC Networks' and Power Sources' Line and Loop Resistances

Substations DC control circuits, supplying DC sources, DC charging stations and batteries with electrical installation's circuit protection is based on internal resistance of the source, power lines and grounded loops. Automatic trip-out protection with fuses will regularly operate in case of faults, errors or shorts where resistances in the circuit are low enough.



Industrial solution supports live testing without disconnection of the DC batteries or DC power sources during testing.

The purpose of periodical inspections of DC circuits is to show bad contacts on bus bars, condition of batteries, conditions of power switches, contactors or fuse holders. The resistance result at the power source need to be compared with the result at the outer edge of the circuit where voltage drops shall not exceed evaluated border limit.

Internal resistance of the batteries shows their quality and condition. It can be measured in either parallel or series connection, either whole system or partially. MI 3144 compares loaded and unloaded battery's voltage. Measured and calculated values are compared to the reference. The batteries from DC 3 V up to DC 260 V can be evaluated.

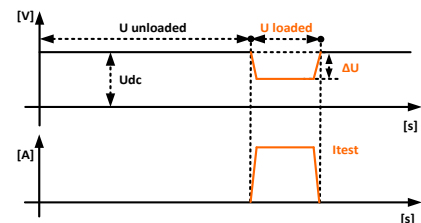
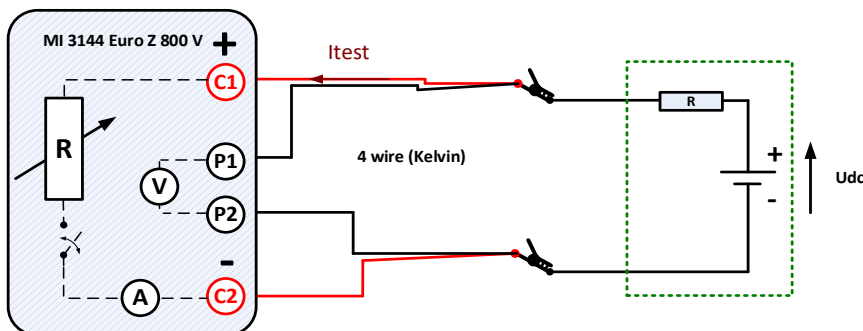

Live testing Loop Resistance of DC Networks and DC Power Sources for wide range of applications. Quality of the battery banks and separate cells could be evaluated and measured in percentage of the voltage drop during loading. Cells shall be compared one to another to eliminate possible power failures.

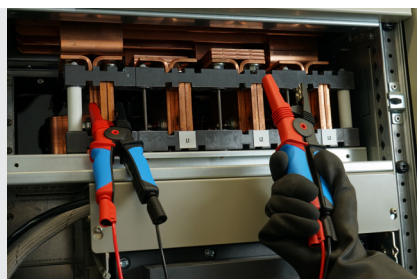

Four-wire type of connection with Kelvin crocodiles for high precision and stable results eliminates connection problems even in an aggressive environment.



Internal resistance of the Power Source with Automatic trip-out ability evaluation with high accuracy on DC circuits.



Measured result of live loop resistance on DC control circuits at the field end to be compared with battery source for evaluation of the conductors, relays and contacts quality.

Application Note - 5 (MI 3144)

Flex & Iron One-Clamp High Current dR 300A Grounding method for Lightning systems

Lightning protection on buildings with faraday cages and metal shields connected to conductive construction of the building must be tested periodically to check the connections from the lightning rods to the grounding nets.

Conductive paths through the building must evenly dissipate power of the lightning strike all the way down to the ground. The voltage drops during lightning discharge throughout the building will then be low enough to protect living beings and inbuilt equipment.



High current dR 300A testing with MI 3144 Euro Z provides enough power while still being small and portable enough to be easily brought to any roof or part of industrial platform.

External flex clamps can be wrapped around any metal leg or construction with high cross-section. Partial currents through building's construction, metal straps or cable screens can be evaluated.

Synchronized testing of voltage drops in the building's surroundings during high current pulse shows potential risks in case of a bad connection to the ground net due to aging, corrosion or mechanical damage.

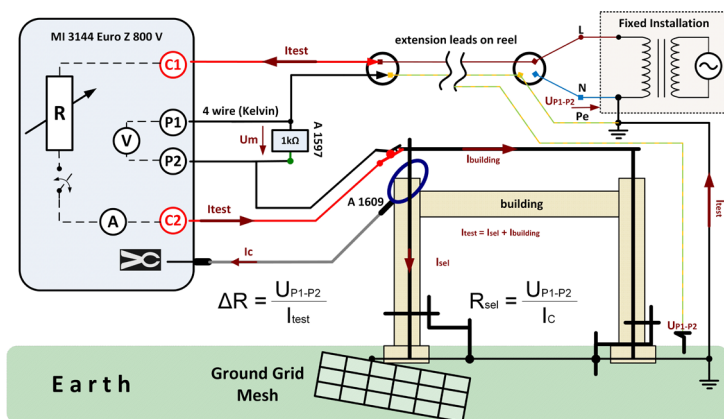

Body resistance simulation with 1kOhm adapter A1597 for correct Touch Voltage calculation.

High Current testing with controlled power management of the source pulsing current. Safety mannered procedure where partial current I_c measured in synchronization with voltage drop U_{P1-P2} gives result of separate earthing leg resistance.



Flex Clamps measure selective currents to the ground during generated pulse.



Robust G-clamp connects the test leads through colored or rusted surfaces to conduct hi test current to grounded paths.



Portable protected travel case to transport all the necessary equipment to the test site.

Application Note - 6 (MI 3144 and MI 3143*)

High Current dR 300A Integrity of Grounding system with Flex and Iron One-Clamp method*

Ground impedance and ground bonding measurements have to be performed, after installation and periodically to verify the continuity of buried ground conductors and connectors to the ground.

Properly designed, installed, and maintained grounding grid eliminates the shock hazard and disturbances to the installation that can arise due to fault currents.



The ground integrity test should be performed before any other tests for safety reasons and for quality control for large ground grid systems such as power plants, substations, switchyards, railways or any industrial platform.

Lightning or fault-related surge protection prevents damage to sensitive electronic circuits in the buildings, control gears, antenna towers, remote control stations and similar.

Ground grid integrity measurements may be referenced to standard IEEE-81.2012 parts 10.2 and 10.3 by injecting a high test current.

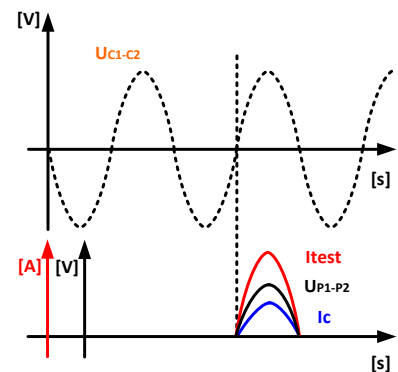
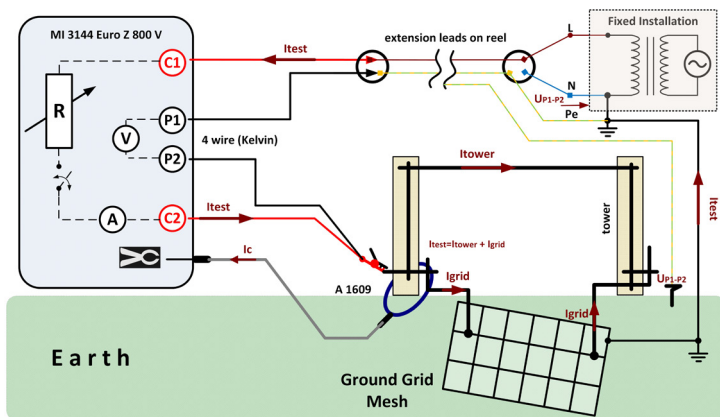

Measurement is performed within a half-period and therefore the safety condition is fulfilled even during high current pulse with up to several hundred volts. Synchronized measuring method and a higher current amplitude improves the immunity against voltage noise.



Flex or iron Clamps measures selective current from riser to grid.



Kelvin Crocodiles ensure robust 4-wire connection for reliable results.



G-clamp reference point on the grid connection improving the result stability.

Application Note - 7 (MI 3144)

ELR (MRCD) trip-out Current and trip-out Time testing

The MI 3144 Euro Z 800 V instrument supports testing of ELRs (MRCDs) without integral current breaking devices and with separate sensing means.



Note (acc.to IEC 60947-2 Annex M)

The Earth Leakage Relay (ELR) or Modular Residual Current Devices (MRCD) shall be installed, mounted and wired according to the manufacturer's instructions. Unless otherwise specified, it is connected to a test equipment, as specified by the manufacturer, representing normal service conditions for the output circuit in order to verify the change in the status of the output. For the measurement of the combination time, the ELR is connected

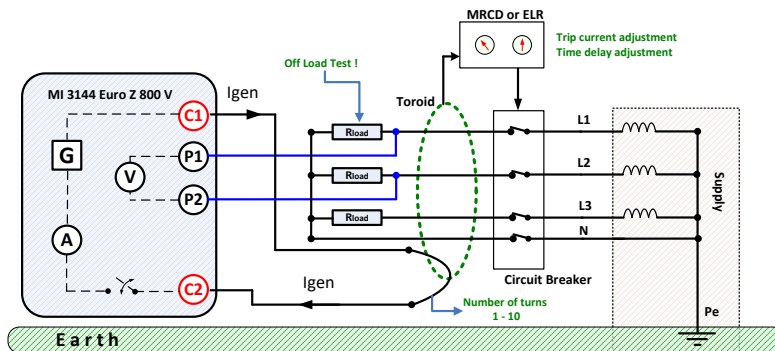
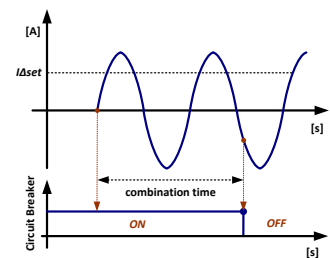

ELR Current Injection Test

Verifying the operation in case of a steady increase of the residual current.

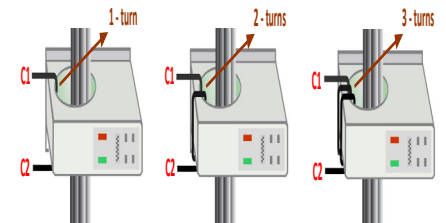

Earth potentials, step and touch voltages may be referenced to standard IEEE-81.2012 part 9. The measured values should be compared to referenced body withstanding values.

Always count the inner number of turns!

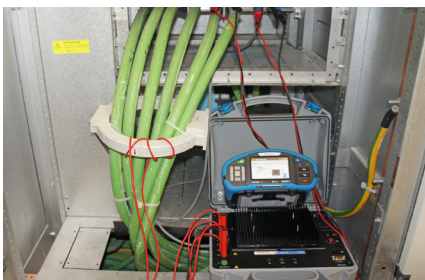

The instrument measures the combination time (ELR + Circuit Breaker) from establishing the current (I_{set}) to the change detected in the circuit breaker OFF state.

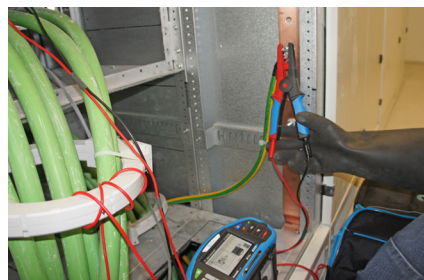

Multiple turns supported through the MRCD's remote sensor can generate high fault current for adjustment of industrial platform protection.



Following IEC 60947-2 Annex M standard brings multiple solution to fulfil industrial demands.

Application Note - 8 (MI 3144 and MI 3143)

Earth Potentials by method of measuring Step, Touch and Transfer voltages

Measuring step and touch voltages caused by injecting a known amount of current into the ground system offers better assurance that the grid meets its design objectives.

Actual magnitude of step, touch and transfer voltages can then be determined by scaling the measured values up to the prospective fault current. Such current can occur during phase to ground error or lightning strike.

Following the IEEE 81 rules or any other local regulation or standard like IEC 62305 the step and contact or touch and transfer voltages shall be tested in a safe manner periodically.

The most critical situations need to be observed in surrounding of any metal construction, building with LPS or in surrounding of any kind of production, generation, distribution or transmission of the energy.

Exposed parts where the dangerous voltages could be transferred to longer distances are meshes, fences, pipes, pylons, bridges, rails, cable's shields, metal stripes or similar.

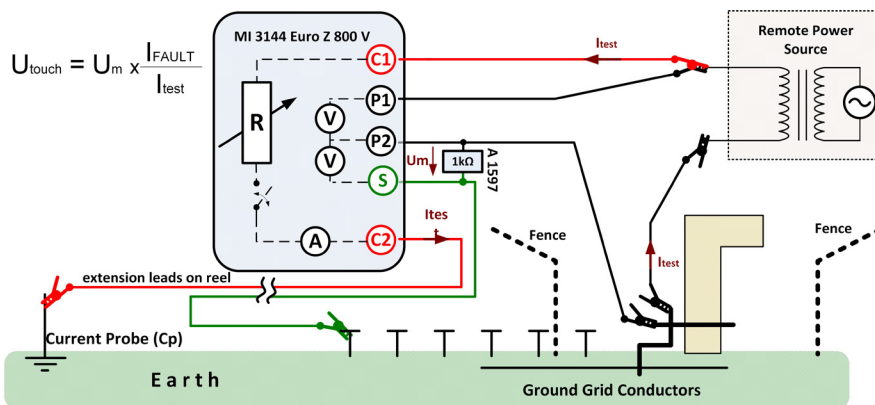

Earth potentials, step and touch voltages may be referenced to standard IEEE-81.2012 part 9. The measured values should be compared to referenced body withstanding values.



Due to short 0.01s duration of the test, the operation is safe for people in surrounding even for public places measurements.



Well conducted probes - weights of 25 kg / 200 cm² or two step-on plates used for proper connection to grounding material.



Copper probes - weights of 5 kg to be combined with 25 kg weight in addition for proper connection to wet concrete material.

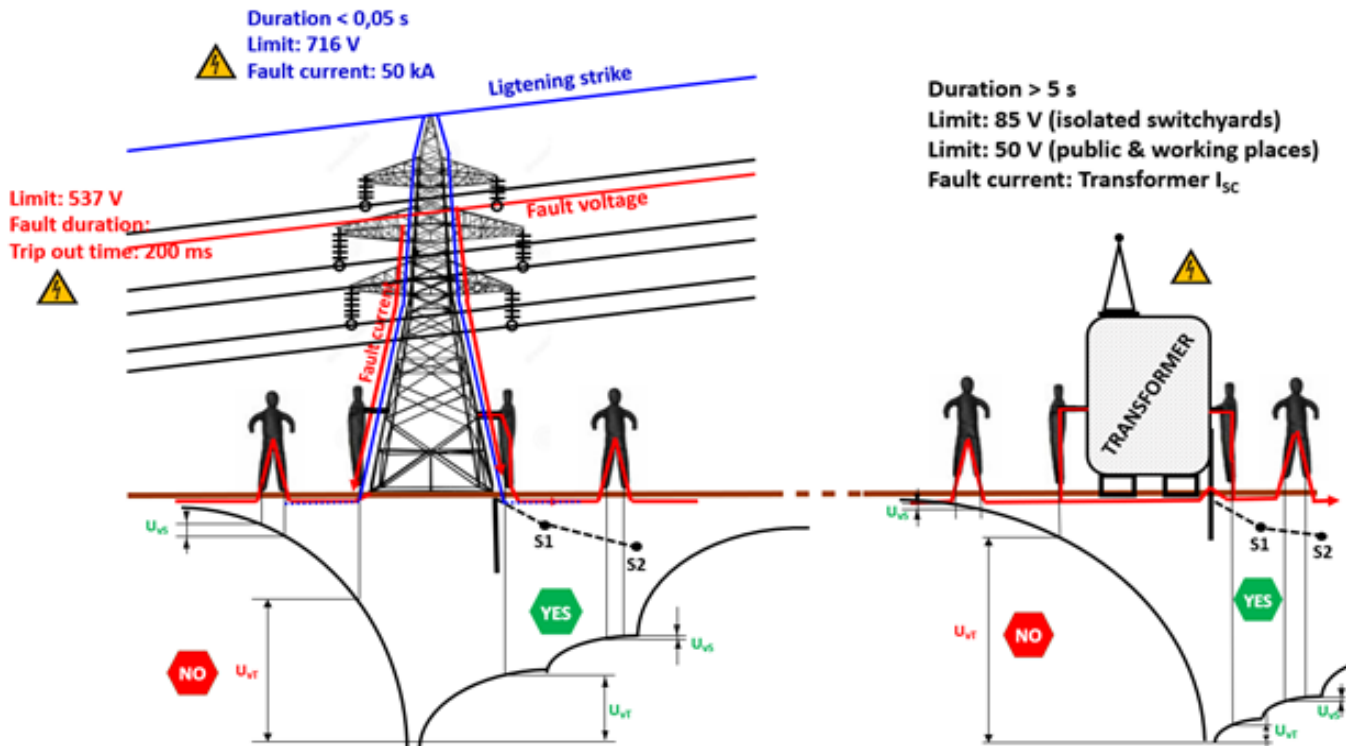

Touch Voltage calculation on the instrument screen can be selected from the list of parameters. Fault current in the equation is a manually inserted value of the predicted power of a lightning strike, e.g. 50 kA. Combined with the body simulator A 1597, the measurement will be scaled to the potential risk around lightning systems.

Fault duration (s)	Permissible body current I_B (mA)	Permissible touch voltage U_{Tp} (V)
0,05	900	716
0,10	750	654
0,20	600	537
0,50	200	220
1,00	80	117
2,00	60	96
5,00	51	86
10,00	50	85

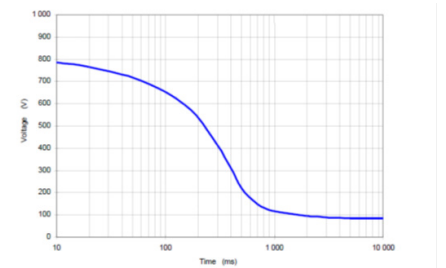

Figure 12 – Permissible touch voltage U_{Tp}

Example of permissible body current I_B and calculated values of the permissible touch voltage U_{Tp} depending on the fault duration t_f



Body resistance simulation with 1 kOhm adapter A1597 for correct Touch Voltage calculation.



Bundle set with all the accessories in a portable IP67 protected case for field transport.



Extremely portable and easy to handle. Equipped with robust wheels and extended arm with added holders for backside mounted extension cable reel.

METREL d.d.
Measuring and Regulation Equipment Manufacturer
Ljubljanska 77, SI-1354 Horjul, Slovenia
T +386 (0)1 75 58 200, F +386 (0)1 75 49 226
metrel@metrel.si, www.metrel.si

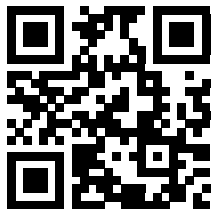

Note! Photographs in this catalogue may slightly differ from the instruments at the time of delivery.
Subject to technical change without notice.

BROCHURE_MI 3144 Euro Z 800 V & MI 3143 Euro Z 440 V_2020_Ang_December